

2023 CURB INSTALLATION AND REPLACEMENT CONTRACT

Village of Ardsley
Village of Elmsford
Village of Hastings-on-Hudson
Village of Irvington
Village of Sleepy Hollow
Village of Tarrytown

Prepared by:

Village of Hastings-on-Hudson
Office of the Village Manager
7 Maple Avenue
Hastings-on-Hudson, NY 10706

April 2023

TABLE OF CONTENTS

| <u>SECTION</u> | <u>PAGE NUMBER</u> |
|--|--------------------|
| A. NOTICE TO BIDDERS | A-1 |
| B. INSTRUCTIONS TO BIDDERS | B-1 – B-3 |
| C. BID PROPOSAL | C-1 – C-9 |
| D. FORMS | |
| Form of Agreement | D-1 – D-4 |
| Form of Bid Bond | D-1 |
| Form of Performance Bond and Labor & Material Payment Bond | D-1, D-5 – D-7 |
| Form of General Release | D-1, D-7 |
| Form of Maintenance Bond | D-1, D-8 – D-10 |
| E. INSURANCE | E-1 – E-2 |
| F. LABOR PROVISIONS | |
| Compliance with Labor Law | F-2 |
| Non-Discrimination Clause | F-3 – F-4 |
| N.Y.S. Prevailing Wage Rates | F-5 – F-78 |
| G. GENERAL CONDITIONS | |
| 101. Definitions | G-1 |
| 102. Superintendence of Contractor | G-2 |
| 103. Subcontracts | G-2 |
| 104. Other Contracts | G-2 - G-3 |
| 105. Responsibilities of Contractor | G-3 |
| 106. Fitting and Coordination of the Work | G-3 |
| 107. Mutual Responsibility of Contractor | G-3 |
| 108. Assignment or Novation | G-3 |
| 109. Progress Schedule | G-4 |
| 110. Communications | G-4 |
| 111. Payments to Contractor | G-4 – G-6 |
| 112. Changes in the Work | G-6 – G-9 |
| 113. Claims for Extra Cost | G-9 – G-10 |
| 114. No Options Paid | G-10 |
| 115. Time and Materials Work Notification | G-10 |
| 116. Termination; Delays and Extensions; Liquidated Damages | G-10 – G-13 |
| 117. Engineer's Authority | G-13 |
| 118. Technical Specifications and Contract Drawings | G-13 |
| 119. Requests for Supplementary Information | G-13 |
| 120. Shop Drawings | G-13 – G-15 |

SECTION**PAGE NUMBER****G. GENERAL CONDITIONS (continued)**

| | |
|--|-------------|
| 121. Samples, Certificates and Tests | G-15 – G-17 |
| 122. Materials and Workmanship | G-17 – G-18 |
| 123. Permits and Codes | G-18 – G-19 |
| 124. Care of Work | G-19 – G-20 |
| 125. Accident Prevention | G-20 – G-21 |
| 126. Sanitary Facilities | G-21 |
| 127. Use of Premises | G-21 |
| 128. Removal of Debris, Cleaning, etc. | G-21 |
| 129. Layout of Work | G-21 – G-22 |
| 130. Blasting | G-22 – G-23 |
| 131. Inspection/Acceptance of the Work | G-23 – G-24 |
| 132. Final Inspection | G-24 |
| 133. Insurance | G-24 |
| 134. Warranty of Title | G-24 |
| 135. General Guarantee | G-24 – G-25 |
| 136. No Arbitration | G-25 |
| 137. Risk of Loss | G-25 |
| 138. Required Provisions Deemed Inserted | G-25 |
| 139. Corrections | G-25 |
| 140. Safety Provisions | G-25 – G-26 |
| 141. Connecting to Existing Work | G-26 |
| 142. Existing Improvements | G-26 |
| 143. Access to Site | G-26 – G-27 |
| 144. Access to Adjacent Properties | G-27 |
| 145. Use of Roadways | G-27 – G-28 |
| 146. Indemnity Clause | G-28 |
| 147. Disputes | G-28 – G-29 |
| 148. General Municipal Laws of New York State | G-29 |
| 149. "Or Equal" Clause Unless Otherwise Specified | G-29 |
| 150. Construction, Excavation and Demolition Operations at or near Underground Facilities | G-29 – G-30 |
| 151. Review by Owner | G-30 |
| 152. Deductions for Uncorrected Work | G-30 |
| 153. Patents | G-30 |
| 154. Information from Owner | G-30 |
| 155. Existing Utilities, Structures and Fixtures | G-30 – G-31 |
| 156. Control of Existing Flows | G-31 |
| 157. Sewage, Surface, Groundwater & Flood Flows | G-31 – G-32 |
| 158. Weather Conditions/Work in Freezing Weather | G-32 |
| 159. Maintenance and Protection of Traffic | G-33 |
| 160. Hours of Work | G-33 |
| 161. Watchman | G-34 |
| 162. Field Copies | G-34 |
| 163. Emergency Work | G-34 |
| 164. Protection | G-34 – G-35 |
| 165. Payment for General Conditions | G-35 |

SECTION**PAGE NUMBER****G. GENERAL CONDITIONS (continued)**

166. Damage to Private Property

G-35

167. Restoration

G-35 – G-36

168. Site Visitation

G-36

H. SPECIAL CONDITIONS (201-216)

H-1 - H-2

I. INDEX TO TECHNICAL SPECIFICATIONS

I-1

10A Asphalt Miscellaneous Sidewalks, Swales,
and Driveways

10A-1 – 10A-2

76 Maintenance and Protection of Traffic

76-1 – 46-2

97 Concrete Curbs

97-1 – 97-3

98P Stone Paver Driveway Apron

98P-1 – 98P-2

99 Reinforced Concrete Sidewalks

99-1 – 99-5

102HMA Catch Basin Frames and Grates – Adjustment

102HMA-1 – 102HMA-3

127 Restoration

127-1 – 127-4

APPENDIX

A Summary of Quantities

B Individual Quantities and Locations

C Details

NOTICE TO BIDDERS

VILLAGE OF ARDSLEY | VILLAGE OF ELMSFORD VILLAGE OF HASTINGS-ON-HUDSON VILLAGE OF IRVINGTON | VILLAGE OF SLEEPY HOLLOW VILLAGE OF TARRYTOWN

NOTICE IS HEREBY GIVEN that sealed bids will be received by the Village Clerk of the Village of Hastings-on-Hudson until 11:00 AM on May 12, 2023, Hastings-on-Hudson, Municipal Building, 7 Maple Avenue, Hastings-on-Hudson, NY 10706, at which time and place said sealed bids will be publicly opened and read aloud for the furnishing and/or placing of the following materials:

The project consists of installing approximately 12,409 linear feet of concrete curb, along with sidewalks, pavers, and asphalt.

Specifications and Bid proposal forms will be available on April 21, 2023 online at <https://www.hastingsgov.org/village-clerk/pages/rfps-and-bid-documents> or by sending an email to the Village Clerk at Acostantini@hastingsgov.org. All bidders are to notify Anthony Costantini upon downloading the project documents.

In addition to the above, the Village of Hastings-on-Hudson has partnered with BidNet as part of the Empire State Purchasing Group and will post our bid opportunities and any addendums to this site. As a vendor, you can register with Empire State Purchasing Group and be sure that you see all of the Village's available bids, addendums, and opportunities. Detailed plans and specifications for said bid may be obtained through the Empire State Purchasing Group at the following link: <http://www.bidnetdirect.com/new-york/hastings-on-hudson>

Bids shall be made on the Proposal Forms, furnished with the Specifications and must be accompanied by a Bid Bond acceptable to the Village, or a certified cashier's check, drawn on a solvent bank account in the amount of not less than 5% of the total amount of the Bid. Checks shall be made payable to the Village of Hastings-on-Hudson, New York, and are to be held by the Village as a guarantee for the proper execution and delivery of the Contract and bonds to secure the faithful performance thereof. In default of such execution and delivery of Contract and Bonds, the amount of the deposit represented by the check shall be forfeited to and retained by the Village of Hastings-on-Hudson as liquidated damages.

All bids must be submitted in sealed envelopes plainly marked **“Bid for 2023 Curb Installation and Replacement – due May 12, 2023.”**

Contractor shall coordinate curb installation with the Village paving work. Roads which require curbing and paving shall not be paved prior to curb installation.

The cooperating Villages reserve the right to accept or reject any or all bids and to waive any informalities at their discretion, and to award contracts in a manner deemed to be in the best interests of the cooperating Villages even if such award is for other than the lowest bidder.

All technical questions should be directed in writing to Mary Beth Murphy by email to Villagemanager@hastingsgov.org or by mail to 7 Maple Avenue, Hastings-on-Hudson, NY 10706.

Anthony Costantini
Village Clerk

SECTION B

INSTRUCTIONS TO BIDDERS

1. **DOCUMENTS:** Complete sets of Bidding Documents will be issued for bidding purposes as stated in the "Notice to Bidders." A complete set of Documents consists of the following:
 - a. A bound copy of the Specifications
 - b. Addenda (if any)
 - c. Contract Plans (if any)
2. **PROPOSALS:** To be considered, proposals on the forms included herein, must be a set-in accordance with these Instructions to Bidders. All bids must be submitted on the prescribed forms which are bound in the specifications as Section C. All blank spaces for bid prices must be filled in, in both words and figures, either typed or in ink.

Proposals that contain any omission, erasures, alterations, additions, or items not called for in itemized Proposal, or that contains irregularities of any kind, may constitute sufficient cause for rejection of the bid. In case of any discrepancy in the price or amount bid in the Proposal, the price, as expressed in words, shall govern. All bids must be submitted in sealed envelopes addressed to Village Clerk, Village of Hastings-on-Hudson, Westchester County, New York and be clearly identified with (1) Project Name, (2) Name of Bidder and address. Proposals shall be signed with name typed below signature. The Bidder's seal, if a corporation, shall be affixed under the Bidder's signature. Telephone or telegraphic bids will not be accepted.

3. **QUALIFICATIONS OF BIDDERS:** The Owner may make such investigations as he deems necessary to determine the qualifications of the Bidder to perform the work, and the Bidder shall furnish information and data for this purpose as may be required. The Owner reserves the right to reject any bid if the evidence submitted by a Bidder, or the investigation of such Bidder, fails to satisfy the Owner, that such Bidder is properly qualified to carry out obligations of the Contract and to complete the work contemplated therein within the time designated. Fraudulent statements shall cause rejection of Proposal and forfeiture of bid security.
4. **CONDITIONS OF WORK:** Each bidder must inform himself fully of conditions relating to the construction and labor under which work will be performed. Failure to do so will not relieve a successful Bidder of his obligation to furnish all material and labor necessary to carry out the provisions of the contract and to complete the work for the consideration set forth in his Bid. Bidders' attention is direction to Paragraph 1 of the Bid Proposal, in which the Bidder certifies that he has examined the site. If rock probes or test borings have been made by the Owner, they will be made available to the Contractor for inspection on the same conditions. Bid shall include the complete costs of furnishing all materials, with the Drawings and Specifications and all other expenses incidental thereto. Local and State sales taxes shall not be included in the bid. Insofar as possible, any Contractor in the carrying out of his work must employ such methods or means as will not cause any interruption of or interference with the work of any other Contractor, or of the proper functioning of the existing facilities of adjacent or contingent properties.

5. **ADDENDA AND INTERPRETATION:** Every request for information or interpretation of Bidding Documents or Drawings must be addressed in writing to the Village Manager, Village of Hastings-on-Hudson and, to be given any consideration, must be received at least ten (10) days prior to the date fixed for the opening of bids. Any and all such interpretations, any supplemental instructions, will be in the form of written Addenda and will be mailed to all prospective Bidders. The failure of any Bidder to receive any such Addenda will not relieve the Bidder of any obligation under his Bid submitted. Any Addenda so issued shall become part of the Bidding Documents. Reception of Addenda shall be noted on the “Bid Form.”

6. **BID SECURITY:** Each bidder is required to deposit at the time of submission of his bid, a Bid Bond or certified check in an amount representing five percent (5) of his bid payable to the Owner, which amount the Bidder agrees is to be forfeited as liquidated damages and not as a penalty if in case he is awarded the contract, and he shall thereafter fail to execute a Contract with the Owner under the conditions of his Proposal or to furnish the bonds required for the faithful performance of this Contract. Bidders who submit certified checks must accompany them with a Consent of Surety from a recognized Bonding Company agreeing to supply a Performance Bond and Labor and Materials Bond if the contract is awarded to the Bidder.

Such bid security will be returned to all except the three lowest formal Bidders within three days after the formal opening of the Bids, and the remaining bid security will be returned to the other bidders after the Owner and the accepted Bidder have executed the Contract Documents. In the event no Contract has been so executed within forty-five (45) calendar days after the date of the opening of the bids, upon the demand of the Bidder, so long as he has not been notified of the acceptance of his bid, his bid security will be returned. The Bid Security of the successful Bidder will be retained until the filing and approval of the bonds and insurance.

7. **INSURANCE REQUIRED:** The successful Bidder will be required to procure and pay for the following types of insurance, in accordance with the provision listed in Pages E-1 through E-3. Additionally the successful bidder will be required to procure separate insurance policies for each municipality listed in section A “NOTICE TO BIDDERS”.

- a. General Liability Insurance
- b. Automobile Liability Insurance
- c. Compensation, Disability and Employer’s Liability Insurance
- d. Unemployment Insurance

8. **SECURITY FOR FAITHFUL PERFORMANCE:** The Contractor shall, prior to execution of the Contract submit two separate executed bonds per municipality, (1) a Performance Bond in an amount equal to one hundred percent (100%) of the accepted bid as security for the faithful performance of the terms, covenants and conditions of the Contract; and (2) a Labor and Material Payment Bond for the full amount of the Contract price guaranteeing the full payment of all persons performing labor or furnishing material or rentals, under the contract.

The Bonds shall be prepared as specified in Section D – Form of Performance Bond and Labor and Material Bond, and shall have as Surety thereon such Surety Company or companies as are acceptable to the Owner and are authorized to transact business in the State of New York.

In addition, at the time of final payment, a one year Maintenance Bond Guaranteeing against defective materials and workmanship will be required in an amount equal to one hundred percent (100%) of the contract amount.

9. **FORM OF AGREEMENT:** The form of agreement is included in these documents in Section D. The successful bidder will be required to sign separate agreements with each municipality listed in section A “NOTICE TO BIDDERS”.
10. **AWARD:** The contract will be awarded to the lowest responsible bidder for the base bid amount or the base bid including alternates pursuant to the provisions of the General Municipal Law and what is in the best interest of the Village. The Village Board reserves the right to determine responsibility based on an evaluation of the contractor’s qualifications, experience, organization, finances, past performance, and other applicable factors. The Village Board further reserves the right to reject any and all bids.

Each individual village reserves the right to accept or decline all or parts of the bid including additional alternatives for reflectorized pavement markings and concrete curbing.

11. **OWNER:** Village of Ardsley, Westchester County, New York
Village of Elmsford, Westchester County, New York
Village of Hastings-on-Hudson, Westchester County, New York
Village of Irvington, Westchester County, New York
Village of Sleepy Hollow, Westchester County, New York
Village of Tarrytown, Westchester County, New York
12. **SALES TAX EXEMPTION:** Under Chapter 513 of the Laws of New York 1974, all materials and supplies sold to a Contractor and which are to become an integral, component part of a structure, building or real property owned by an exempt organization such as the Village of Hastings-on-Hudson are exempt from the payment of New York State Sales or compensator use taxes. Therefore, the Contractor should not include any amount in its bid price to cover sales taxes for the above items.
13. **REQUIRED SUBMISSIONS:** Prior to award, the successful bidder will be required to meet the following requirements:
 - a. The successful bidder must provide the Village with a certificate issued by the Secretary of State that the Corporation is authorized to do business within the State and is presently in good standing. If the entity to whom the bid is awarded is not a corporation, it would be required that the entity’s certificate of doing business, which should be on file in the County Clerk’s office, be provided. (This would also hold true in the case of joint ventures which would be required to disclose the underlying entities which make up the joint venture and the supplying of the requisite certificate of doing business of each such entity.)
 - b. A Statement by the successful bidder that no officer, director or stockholder (if less than 10 stockholders) of the successful bidder is an officer or employee of the Village or is a relative of any such Village officer or employee. If such officer, director or stockholder does exist, their names and relationship should be disclosed to the Village.
14. **PIGGYBACKING:** This contract is made available for use by other governmental entities under the same terms and conditions pursuant to NYS General Municipal Law §103.

SECTION C
BID PROPOSAL

2023 CURB INSTALLATION AND REPLACEMENT CONTRACT

**Village of Ardsley, New York
Village of Elmsford, New York
Village of Hastings-on-Hudson, New York
Village of Irvington, New York
Village of Sleepy Hollow, New York
Village of Tarrytown, New York**

TO:

Bid Submitted By:

Village of Hastings-on-Hudson
Office of the Village Clerk
7 Maple Avenue
Hastings-on-Hudson, NY 10706

(Name)

(Address)

(Telephone #)

(Federal ID #)

1. I/We do hereby declare that I/we have carefully examined the Instructions to Bidders, the Plans, Profiles and other drawings and the Specifications relating to the above entitled matter and the work, and have also examined the site.
2. I/We do hereby offer and agree to furnish all materials, to fully and faithfully construct, perform and execute all work in the above titled matter in accordance with the Plans, Drawings, and Specifications relating thereto, and to furnish all labor, tools, implements, models, forms, transportation and materials necessary and proper for the purpose for the price/prices as given on the bid forms.
3. I/We do hereby declare that the prices so stated cover all expenses of every kind incidental to the completion of said work, and the contract therefor, including all claims that may arise through damages or any other cause whatsoever.
4. I/We do hereby agree that I/we will execute a contract therefor, containing all the terms, conditions, provisions, and covenants necessary to complete the work according to the Plans and Specifications therefor within fifteen (15) business days after the award of the contract, and if I/we fail to execute said contract within said period of time, that the Village Board shall have the power to rescind said award and also that the said Board shall retain the proceeds of the certified check, or require the payment of the sum of the bid bond. The Contract execution will serve as the official notification to commence work.
5. I/We do also declare and agree I/we will commence the work within five (5) days after the contract execution and will complete the work fully and in every respect on or before the time specified in said contract and do authorize the said Board, in case of failure to complete the work within such specified time, to employ such men, equipment and materials as may be necessary for the proper completion of said work and to deduct the cost

thereof from the amount due under the contract. I/we further agree that the Owner may deduct for liquidated damages the sums set forth in the Special Conditions if I/we fail to complete the work within the time limits specified.

6. I/We hereby affirm that by submission of this bid, each bidder and each person signing on behalf of any bidder certifies, and in the case of a joint bid, each party thereto certifies as to its own organization, under the penalty of perjury, that to the best of knowledge and belief;
 - (a) The prices in this bid have been arrived at independently without collusion, consultation, communication, or agreement, for the purpose of restricting competition, as to any matter relating to such prices with any other bidder or with any competitor; and
 - (b) Unless otherwise required by law, the prices which have been quoted in this bid have not been knowingly disclosed by the bidder and will not knowingly be disclosed by the bidder prior to opening, directly or indirectly, to any other bidder or to any competitor; and
 - (c) No attempt has been made or will be made by the bidder to induce any other person, partnership or corporation to submit or not to submit a bid for the purpose of restricting competition; and
 - (d) No member of the Village Board or any officer or employee of any of the Villages of Ardsley, Dobbs Ferry, Elmsford, Hastings-on-Hudson, Irvington, and Tarrytown, or person whose salary is payable in whole or in part from the said Village Treasury is, shall be or become interested, directly or indirectly, as a contracting party, partner, stockholder, surety or otherwise, in this bid, or in the performance of the Contract, or in the supplies, materials or equipment and work or labor to which it relates, or in any portion of the profits thereof.
7. I/We hereby further agree that this proposal is a firm bid and shall remain in effect for a period of at least forty-five (45) calendar days from the date of the opening bids, and that within said period of forty-five (45) days, the Village will accept or reject this proposal, or this time period may be extended by mutual agreement.
8. I/We do hereby declare that, if this is a corporate bid, I have been duly authorized to act as the signator on this proposal in behalf of this corporation.
10. I/We hereby affirm, under penalty of perjury, the truth of all statements in this proposal.
11. I/We will accept, in full payment for the completed work, the following unit prices as my/our base bid.
12. I/We hereby agree that I/we shall make no claim on account of any variation of the approximate estimate in the quantities of work to be done, whether the actual quantities are greater, smaller or completely deleted. A change in the quantity of any item shall not be regarded as sufficient grounds for a change in unit price of that item.

***The TOTAL BID** shall be the sum of the extensions (unit price multiplied by estimated quantity, for each item). It is stated here only as a convenience for comparison of bids. If there are any errors in addition or multiplication, the unit prices for each item shall govern, and the bid comparison will be made on the basis of correct arithmetic applied to these unit prices. In case of a discrepancy between the unit price in words and the unit price in numbers, the unit price in words shall govern.

The estimated quantities are not guaranteed, and are only for bid comparison purposes and final payment will be made for actual quantities regardless of the estimated quantities contained herein.

(Legal Name of Bidder)

Date: _____

(Authorized Signature)

Corporate Seal
(if incorporated)

Bidder acknowledges receipt of Addenda as follows:

_____ (Signature)

_____ (Signature)

_____ (Signature)

STATEMENT OF QUALIFICATIONS

The following is a list of places where we have performed work of similar character and magnitude within the last five years, together with references:

| LOCATION | DESCRIPTION OF WORK | APPROXIMATE COST | NAME & PHONE OF ENGINEER/OWNER |
|----------|---------------------|------------------|--------------------------------|
| | | | |
| | | | |
| | | | |
| | | | |
| | | | |
| | | | |
| | | | |
| | | | |
| | | | |
| | | | |
| | | | |
| | | | |
| | | | |
| | | | |
| | | | |
| | | | |
| | | | |
| | | | |
| | | | |
| | | | |

The full name and places of residence of all persons and parties interested as principals in the foregoing proposal are as follows:

| | |
|-------|-------|
| _____ | _____ |
| _____ | _____ |
| _____ | _____ |
| _____ | _____ |
| _____ | _____ |

BID PROPOSAL – 2023 CURB INSTALLATION AND REPLACEMENT CONTRACT
VILLAGE OF ARDSLEY - VILLAGE OF ELMSFORD
VILLAGE OF HASTINGS-ON-HUDSON
VILLAGE OF IRVINGTON – VILLAGE OF SLEEPY HOLLOW - VILLAGE OF TARRYTOWN

Note: Unit prices are to be written in both words and numbers. In case of discrepancy, those shown in words shall govern. All prices are in dollars and cents.

| SPEC SECT | BID ITEM | ESTIMATED QUANTITIES | UNITS | UNIT PRICE | UNIT PRICE | TOTAL |
|--|--|----------------------|-------|-------------|--------------|-----------------------|
| | | | | (IN WORDS) | (IN NUMBERS) | QUANTITY x UNIT PRICE |
| 10A | Asphalt Miscellaneous Sidewalks, Swales, and Driveways | 3,240 | SF | | | |
| 76 | Maintenance and Protection of Traffic | NP | NP | NON-PAYMENT | NP | 0.00 |
| 97 | Concrete Curb (with GGBFS) | 12,409 | LF | | | |
| 98P | Stone Paver Driveway Apron | 830 | SF | | | |
| 99 | Reinforced Concrete Sidewalks and Ramps (5") | 1,230 | SF | | | |
| 99 | Reinforced Concrete Sidewalks and Ramps (7") | 350 | SF | | | |
| 102MHA-1 | Catch Basin Frames and Grates -Adjustment | 13 | EA | | | |
| 102MHA-2 | Catch Basin Frames and Grates – Replacement | 0 | EA | | | |
| 127 | Restoration | NP | NP | NON-PAYMENT | NP | 0.00 |
| TOTAL BASE BID | | | | | | |
| <p>The total bid shall be the sum of the extensions (unit price multiplied by estimated quantity, for each item). It is stated here only as a convenience for comparison of bids. If there are any errors in addition or multiplication, the unit prices for each item shall govern, and the bid comparison will be made on the basis of correct arithmetic applied to these unit prices. In case of a discrepancy between the unit price in words and the unit price in numbers, the unit prices in words shall govern. The estimated quantities are not guaranteed and are only for bid comparison purposes and final payment will be made for actual quantities regardless of the estimated quantities contained herein. The contractor is further advised that the estimated quantities shown in the Bid Sheets may be reduced or deleted in order to ensure that this Contract can be completed within the budget established for this work. In the event that certain work is deleted or reduced, the Unit Price Bid shall remain in effect for this work.</p> | | | | | | |

NON-COLLUSIVE BIDDING CERTIFICATION

Date: _____

By submission of this bid, each bidder and each person signing on behalf of any bidder certifies, and in the case of a joint bid, each party thereto certifies as to its own organization, under penalty of perjury, that to the best of knowledge and belief:

- (1) The prices in this bid have been arrived at independently without collusion, consultation, communication, or agreement, for the purpose of restricting competition, as to any matter relating to such prices with any other bidder or with any competitor;
- (2) Unless otherwise required by law, the prices which have been quoted in this bid have not been knowingly disclosed by the bidder and will not knowingly be disclosed by the bidder prior to opening, directly or indirectly, to any other bidder or to any competitor; and
- (3) No attempt has been made or will be made by the bidder to induce any other person, partnership or corporation to submit or not to submit a bid for the purpose of restricting competition.

I hereby affirm under the penalties of perjury that the foregoing statement is true.

Company

By

Title

Address

Phone

INDIVIDUAL ACKNOWLEDGMENT

STATE OF NEW YORK)
) SS:
COUNTY OF WESTCHESTER)

On this _____ day of _____, in the year 20 ____, before
me personally came _____ to be known and
known to me to be the person described in and who executed the foregoing instrument, and he acknowledged
to me that he executed the same.

Notary Public

PARTNERSHIP ACKNOWLEDGMENT

STATE OF NEW YORK)
) SS:
COUNTY OF WESTCHESTER)

On this _____ day of _____, in the year 20 ____, before
me personally came _____,
a member of the co-partnership of _____,
to me known and known to me to be the person described in and who executed the foregoing instrument, and
he acknowledged to me that he executed the same as and for the act and deed of the said co-partnership.

Notary Public

CORPORATION ACKNOWLEDGMENT

STATE OF NEW YORK)
) SS:
COUNTY OF WESTCHESTER)

On this _____ day of _____, in the year 20 ____, before
me personally came _____
to me known, who, being by me duly sworn, did depose and say that he resides in/at _____

that he is the _____ of the _____

_____, the corporation described in and which executed the
foregoing instrument, that he knows the corporate seal of the said corporation, that the seal affixed to the said
instrument is such corporate seal; and that it was so affixed by order of the Board of Directors of the said
corporation, and that he signed his name thereto by like order.

Notary Public

CERTIFICATE OF COMPLIANCE
WITH NYS SEXUAL HARASSMENT LAW

By submission of this bid, each bidder and each person signing on behalf of any bidder certifies, and in the case of a joint bid each party thereto certifies as to its own organization, under penalty of perjury, that the bidder has and has implemented a written policy addressing sexual harassment prevention in the workplace and provides annual sexual harassment prevention training to all of its employees. Such policy shall, at a minimum, meet the requirements of section 201-g of the labor law.

(Legal Name of Bidder)

Date: _____

By: _____
(Authorized Signature)

**CERTIFICATION OF COMPLIANCE WITH THE IRAN DIVESTMENT ACT
(To be Completed by Each Bidder)**

Each bidder/proposer, any person signing on behalf of any bidder/proposer and any assignee or subcontractor and, in the case of a joint bid/proposer, each party thereto, certifies, under penalty of perjury, that to the best of its knowledge and belief, that each bidder/proposer and any subcontractor or assignee is not identified on the list created pursuant to paragraph (b) of subdivision 3 of section 165-a of the New York State Finance Law (the "Prohibited Entities List").

During the term of any contract awarded pursuant to this bid, should the Village of Hastings-on-Hudson (the "Village") receive information that a bidder/proposer is in violation of the above-referenced certification, the Village will offer the person or entity an opportunity to respond. If the person or entity fails to demonstrate that he/she/it has ceased engagement in the investment which is in violation of the Act within 90 days after the determination of such violation, then the Village shall take such action as may be appropriate including, but not limited to, seeking compliance, recovering damages or declaring the bidder/proposer in default.

The Village reserves the right to reject any bid or proposal from a bidder/proposer that appears on the Prohibited Entities List prior to the award of a contract and to pursue a responsibility review with respect to any bidder/proposer that is awarded a contract and subsequently appears on the Prohibited Entities List.

I, _____, being duly sworn, deposes and says that he/she
(Name of Individual Signing this Certification)

is the _____ of the _____ and
that neither
(Title/Position of Signer) (Name of bidder/proposer)

the bidder/proposer nor any proposed subcontractor is identified on the Prohibited Entities List.

Print Company Name

By:

Signature

Title

Sworn to before me this
_____ day of _____, 20____

Notary Public

SECTION D

FORM OF AGREEMENT

The Contract form will be as shown on Pages D-2 through D-4.

FORM OF BID BOND

The Bid Bond form will be the "Bid Bond" A.I.A. Document A310,
Dated, February 1970

FORM OF PERFORMANCE BOND AND LABOR AND MATERIAL PAYMENT BOND

The form of Performance Bond and Labor and Material Payment Bond, will be the
"Performance Bond and Labor and Material Payment Bond,"
A.I.A. Document A312, Dated February 1970
These are shown on Pages D-5 through D-8

FORM OF GENERAL RELEASE

The form of General Release is included on Page D-7

FORM OF MAINTENANCE BOND

The form of Maintenance Bond will be shown on Pages D-9 and D-10

PROJECT: 2023 Curb Installation and Replacement Contract

BID DATE: _____

AGREEMENT

THIS AGREEMENT, made this _____ day of _____, 20__

by and between _____ (a

corporation organized and existing under the state of

_____) *~~(a partnership consisting of~~

_____) *~~(an individual trading as~~

New York _____) * (hereinafter called the “**Contractor**”

and Village of _____ hereinafter called the “**Owner.**”

WITNESSETH, that the Contractor and the Owner for the considerations stated herein mutually agree as follows:

Article 1. Statement of Work. The Contractor shall furnish all supervision, technical personnel, labor, materials, machinery, tools, appurtenances, equipment and services, including utility and transportation services and perform and complete all work and required supplemental work for the completion of this Contract in strict accordance with the hereinafter referenced Contract Documents, including all Addenda.

Article 2. The Contract Price. The Owner will pay the Contractor for the performance of the Contract in current funds, for the total quantities of work performed at the unit prices stipulated in the bid for the respective items of work completed subject to additions and deductions as provided in the Section-(112) Changes in the work in the General Conditions.

*Strike out the two terms not applicable.

Article 3. Contract Documents. The Contract Documents shall consist of the following (including their attachments and exhibits):

- | | | | |
|----|--|----|-----------------------------|
| a. | This agreement | f. | Special Conditions |
| b. | Addenda (if any) | g. | General Conditions |
| c. | Invitation for Bids | h. | Technical Specifications |
| d. | Instructions to Bidders | i. | Drawings (if any) |
| e. | Signed Copy of Bid, with all Schedule of Drawings) attachments required for the bidding. | j. | Payment & Performance Bonds |
| | | k. | Certificates of Insurance |

This Agreement, together with other Documents enumerated in this Article 3, which said other Documents are as fully a part of the Contract as if hereto attached or herein repeated, forms the Contract between the parties hereto. In the event that any provision in any component part of this Contract conflicts with any provision of any other component, the part first enumerated in this Article 3 shall govern, except as otherwise specifically stated.

IN WITNESS WHEREOF, the parties hereto have caused this AGREEMENT to be executed in five (5) original copies on the day and year first above written.

ATTEST: _____
(Contractor)

By: _____
(Name)

Title: _____

_____ VILLAGE OF _____
(Owner)

By: _____

STATE OF NEW YORK)
) SS.
COUNTY OF WESTCHESTER)

On the ___ day of _____, 20___, before me personally came _____

To me know, who, being by me duly sworn, did depose and say that he resides in _____

_____, New York; that he/she is the Village Administrator/Manager of the Village of _____, the municipal corporation described in, and which executed the foregoing instrument; that he/she knows the seal of said corporation; that the seal affixed to said instrument is such corporate seal; that it was affixed by order of the Village Board of the said corporation and that he/she signed his/her name thereto by like order.

Notary Public

STATE OF NEW YORK)
) SS.
COUNTY OF WESTCHESTER)

On the _____ day of _____, 20___, before me personally came _____ to me known, who, being by me

duly sworn, did depose and say that he resides in _____

that he is the _____ of _____

the corporation described in and which executed the foregoing instrument; that he knows the seal of said corporation; that the seal affixed to said instrument is such corporate seal; that it was so affixed by order of the Board of Directors of said corporation; and that he signed his name thereto by like order.

Notary Public

CORPORATE ACKNOWLEDGMENT

STATE OF NEW YORK)
) SS.
COUNTY OF WESTCHESTER)

On the _____ day of _____, 20__, before me personally came
_____, to me known, who, being by me duly sworn,

did depose and say that he resides at; _____

that he is the _____ of _____,
the corporation described in and which executed the within instrument; that he knows the seal of said
corporation; that the seal affixed to the within instrument is such corporate seal; and that it was so affixed by
authority of the Board of Directors of said Corporation and that he signed his/her name thereto by like order.

Notary Public

SURETY ACKNOWLEDGMENT

STATE OF NEW YORK)
) SS.
COUNTY OF WESTCHESTER)

On the _____ day of _____, 20__, before me personally came
_____, to me known, who, being by me duly sworn,

did depose and say that he is an Attorney-in-Fact of _____,
the corporation described in and which executed the within instrument; that he knows the seal of said
corporation; that the seal affixed to the within instrument is such corporate seal; and he signed the within
instrument and affixed the said seal as Attorney-in-Fact by authority of the Board of Directors of said
Corporation and by authority of the standing resolutions thereof.

Notary Public

ATTACHMENT:
1. POWER OF ATTORNEY

CORPORATE ACKNOWLEDGMENT

STATE OF NEW YORK)
) SS.
COUNTY OF WESTCHESTER)

On the _____ day of _____, 20__, before me personally came _____, to me known, who, being by me duly sworn,

did depose and say that he resides at; _____

that he is the _____ of _____, the corporation described in and which executed the within instrument; that he knows the seal of said corporation; that the seal affixed to the within instrument is such corporate seal; and that it was so affixed by authority of the Board of Directors of said Corporation and that he signed his/her name thereto by like order.

Notary Public

SURETY ACKNOWLEDGMENT

STATE OF NEW YORK)
) SS.
COUNTY OF WESTCHESTER)

On the _____ day of _____, 20__, before me personally came _____, to me known, who, being by me duly sworn,

did depose and say that he is an Attorney-in-Fact of _____, the corporation described in and which executed the within instrument; that he knows the seal of said corporation; that the seal affixed to the within instrument is such corporate seal; and he signed the within instrument and affixed the said seal as Attorney-in-Fact by authority of the Board of Directors of said Corporation and by authority of the standing resolutions thereof.

Notary Public

ATTACHMENT:
1. POWER OF ATTORNEY

GENERAL RELEASE

(To be submitted with requisition for final payment)

KNOW ALL MEN BY THESE PRESENTS, that, _____
(Contractor)

for and in consideration of the sum of _____ lawful money of the United States of America, to it in hand paid by the Village of _____, have remised, released, quit-claimed, and forever discharged, and by these presents do for its successors and assigns remise, release, quit-claim, and forever discharge the said Village of _____, and its successors and assigns and administrators, of and from any and all manner of action and actions, cause and causes of action, suits, debts, dues, sum and sums of money, accounts, reckonings, bonds, bills, specialties, covenants, contract, controversies, agreements, promises, variances, trespasses, damages, judgments, extents, executions, claims and demands whatsoever in law and equity, which against the said Village of _____ he now has, ever had, or which he or his heirs, executors, or administrators hereafter can, shall, or may have, for upon or by reason of any matter, cause or thing whatsoever, from the beginning of the world to the day of the date of these presents rising out of the construction, in accordance with contract entered into between parties hereto, dated _____, 20__, and any admittance or supplements thereto.

IN WITNESS WHEREOF, the undersigned corporation has caused this agreement to be signed by its and its corporate seal to be hereto affixed and duly attested

by its _____, this ___ day of _____, 20__.

Principal:

(Corporate Seal)

CORPORATE ACKNOWLEDGMENT

STATE OF NEW YORK)
) SS.
COUNTY OF WESTCHESTER)

On the _____ day of _____, 20__, before me personally came _____, to me known, who, being by me duly sworn, did depose and say that (s)he resides in _____;

that he is the _____ of _____ the corporation described in and which executed the within instrument; that he knows the corporate seal of said corporation; that the seal affixed to the within instrument is such corporate seal; and that it was so affixed by authority of the Board of Directors of said Corporation and that he signed his/her name thereto by like order.

Notary Public

FORM OF MAINTENANCE BOND

KNOW ALL MEN BY THESE PRESENTS:

That we, _____ (hereinafter called the Principal) as Principal and the _____, a _____ Corporation with an office and place of business for the State of New York at _____

_____ (hereinafter called the Surety), are held and firmly bound unto the _____

(hereinafter called the Oblige) as Oblige in the sum of: _____

_____ (\$ _____) **DOLLARS**, lawful money of the money of the United States of America, for the payment whereof the Principal and Surety bind themselves, their successors and assigns, jointly and severally, firmly by these presents.

Signed, sealed and dated this _____ day of _____, 20__.

WHEREAS, the Principal heretofore entered into a written contract with Oblige for (enter project name here) _____

WHEREAS, the Contract provides that the Principal shall guarantee _____

NOW, THEREFORE, the condition of this obligation is such, that if the above Principal shall indemnify the Oblige against loss by reason of his materials or workmanship which may appear in the work under said contract within the period of one year (s) from the date of acceptance of the work, then this obligation shall be void; otherwise to remain in full force and effect.

CONTRACTOR AS PRINCIPAL:

SURETY:

Company: _____

Company: _____

Signature: _____

Signature: _____

Corporate Seal
(Contractor)

Corporate Seal
(Surety)

(Corporate and Surety Acknowledgments must be notarized, see page D-11)

CORPORATE ACKNOWLEDGMENT

STATE OF NEW YORK)
) SS.
COUNTY OF WESTCHESTER)

On the _____ day of _____, 20 __, before me personally came
_____, to me known, who, being by me duly sworn, did depose
and say that he resides in _____;

that he is the _____ of _____,
the corporation described in and which executed the within instrument; that he knows the seal of said
corporation; that the seal affixed to the within instrument is such corporate seal; and that it was so affixed by
authority of the Board of Directors of said Corporation and that he signed his/her name thereto by like order.

Notary Public

SURETY ACKNOWLEDGMENT

STATE OF NEW YORK)
) SS.
COUNTY OF WESTCHESTER)

On the _____ day of _____, 20 __, before me personally came
_____, to me known, who, being by me duly sworn,

did depose and say that he is an Attorney-in-Fact of _____,
the corporation described in and which executed the within instrument; that he knows the seal of said
corporation; that the seal affixed to the within instrument is such corporate seal; and he signed the within
instrument and affixed the said seal as Attorney-in-Fact by authority of the Board of Directors of said
Corporation and by authority of the standing resolutions thereof.

Notary Public

ATTACHMENT:
1. POWER OF ATTORNEY

SAMPLE

BOND NO. XXXXXX

AIA Document A312

Performance Bond

Any singular reference to Contractor, Surety, Owner or other party shall be considered plural where applicable.

| | |
|---|-------------------------------------|
| CONTRACTOR (Name and Address: Business): | SURETY (Name and Principal Place of |
| Name | Name |
| Address | Address |
| Address | Address |

OWNER (Name and Address):
Name
Address
Address

CONSTRUCTION CONTRACT

Date:
Amount:
Description (Name and Location):

BOND

Date (Not earlier than Construction Contract Date):
Amount:
Modifications to this Bond:

None See Page 3

CONTRACTOR AS PRINCIPAL

Company: Name (Corporate Seal)

SURETY

Company: Name (Corporate Seal)

Signature: _____
Name and Title:

Signature: _____
Name and Title:

(Any additional signatures appear on page 3)

(FOR INFORMATION ONLY – Name, Address and Telephone)

AGENT or BROKER:
Name
Address
Address
Phone Number

OWNER'S REPRESENTATIVE (Architect, Engineer or other party):

SAMPLE

BOND NO. XXXXXX

AIA Document A312

Payment Bond

Any singular reference to Contractor, Surety, Owner or other party shall be considered plural where applicable.

CONTRACTOR (Name and Address:
Business):

Name
Address
Address

SURETY (Name and Principal Place of

Name
Address
Address

OWNER (Name and Address):

Name
Address
Address

CONSTRUCTION CONTRACT

Date:

Amount:

Description (Name and Location):

BOND

Date (Not earlier than Construction Contract Date):

Amount:

Modifications to this Bond:

None

See Page 3

CONTRACTOR AS PRINCIPAL

Company: Name (Corporate Seal)

SURETY

Company: Name (Corporate Seal)

Signature: _____

Name and Title:

Signature: _____

Name and Title:

(Any additional signatures appear on page 3)

(FOR INFORMATION ONLY – Name, Address and Telephone)

AGENT or BROKER:

Name
Address
Address
Phone Number

OWNER'S REPRESENTATIVE (Architect, Engineer or
other party):

SECTION E

INSURANCE

1. The Contractor, prior to signing of the contract, shall provide to each Village, and maintain throughout the life of the contract, at his own cost and expense, proof of the following insurance by insurance companies licensed in the State of New York.
 - a. General Liability Insurance with limits of no less than \$1,000,000/\$3,000,000 Bodily Injury and Property Damage, and including coverage for:
 - (1) Premises - Operations;
 - (2) Contractual as respect this contract including the indemnification set forth in Section 146 - Indemnity Clause of the General Conditions.
 - (3) Any deductibles shall not be the liability of the Village.
 - b. Owners and Contractors Protective Liability policy - \$1,000,000 single limit endorsed that Village not responsible for premium.
 - c. Automobile Liability Insurance with a single limit of liability per occurrence for bodily injury and per occurrence for property damage at \$1,000,000. This insurance shall include coverage for:
 - (1) Owner automobiles;
 - (2) Hired automobiles;
 - (3) Non-owned automobiles.
 - d. Umbrella Excess Liability Policy, with limits no less than \$5,000,000 each occurrence.
 - e. Compensation, Disability and Employer's Liability Insurance - The Contractor shall take out and maintain during the life of this contract the statutory Workmen's Compensation, Disability, and Employer's Liability Insurance for all of his employees to be engaged in work on the project under this Contract and, in case any such work is sublet, the Contractor shall require the Subcontractor Similarly to provide Workmen's Compensation, Disability, and Employer's Liability Insurance for all of the latter's employees to be engaged in such work.

- f. Unemployment Insurance - The Contractor for the agreed consideration, promises and agrees to pay the contributions measured by the wages of his employees required by State Unemployment Insurance Laws and all amendments thereto, and to accept the account of any contribution measured by the wages as aforesaid of employees of the Contractors and his subcontractors assessed against the owner under the authority of said law.
2. All policies and certificates of insurance of the Contractor shall state that the “Village of _____ is additional insured” under the policy.
3. The Contractor, as part of the Contract, shall agree to the following clauses for all policies and certificates of insurance:
 - a. The insurance companies issuing the policy or policies shall have no recourse against the Village for payment of any premiums or for assessments under any form of policy.
 - b. Any and all deductibles in the above described insurance policies shall be assumed by and be for the account of, and at the sole risk of the Contractor. The Contractor agrees to indemnify and hold harmless the Village and its offices, employees, agents and officials for any and all such deductibles.
 - c. In case of cancellation or material change in any of the policies, thirty (30) days notice shall be given to the Village, by registered mail, return receipt requested.
4. All property losses shall be made payable to and adjusted with the Village.
5. All policies of insurance shall be acceptable to and approved by the Department of Law prior to the inception of any work.
6. Other coverage may be required by the Village based on specific needs.
7. I, at any time, any of the said policies shall be or become unsatisfactory to the Village, as to form or substance, or if a company issuing any such policy shall be or become unsatisfactory to the Village, the Contractor shall promptly obtain a new policy, submit the same to the Department of Law of the Village for approval and submit a certificate thereof as herein above provided. Upon failure of the Contractor to furnish, deliver and maintain such insurance as above provided, this contract, at the election of the Village, may be forthwith declared suspended, discontinued or terminated. Failure of the Contractor to take out and/or to maintain or the taking out and/or maintenance of any required insurance shall not relieve the Contractor from any liability under the contract, nor shall the insurance requirements be construed to conflict with the obligations of the Contractor.
8. In the event that claims in excess of these amounts are filed by reason of any operations under the contract, the amount of excess of such claims, or any portion thereof, may be withheld from payment due or to become due the Contractor until such time as the Contractor shall furnish such additional security covering such claims.

2023 CURB INSTALLATION AND REPLACEMENT CONTRACT

**Village of Ardsley
Village of Elmsford
Village of Hastings-on-Hudson
Village of Irvington
Village of Sleepy Hollow
Village of Tarrytown**

SECTION F

LABOR PROVISIONS

**COMPLIANCE WITH THE LABOR LAW
AND OTHER DEPARTMENT OF LABOR REGULATIONS**

The Contractor shall comply with the applicable provisions of the "Labor Law" as amended, of the State of New York. This Contract shall be void unless applicable sections of said Labor Law are complied with. Each and every provision of law and clause required by law to be part of this Contract shall be deemed to be included herein and this Contract shall be read and enforced as though it were included herein, and if through mere mistake or otherwise any such provision is not included, then upon the application of either party hereto, the Contract shall forthwith be physically amended to make such inclusion.

Specifically, section 200-e, of the Labor Law, as so amended, prohibits in contracts, discrimination on account of race, creed, color, or national origin in employment of citizens upon public works.

There may be deducted from the amount payable to the Contractor by the Owner under this Contract a Penalty of five (\$5.00) dollars for each person for each calendar day during which such person was discriminated against or intimidated in violation of Section 200-e; provided, that for a second or any subsequent violation of the provisions of said paragraph, his Contract may be canceled or terminated by the Owner and all monies due or to become due hereunder may be forfeited.

NON-DISCRIMINATION CLAUSE

During the performance of the Contract, the Contractor agrees as follows:

- a. The Contractor will not discriminate against any employee or applicant for employment because of race, creed, color, or national origin, and will take affirmative action to insure that they are afforded equal employment opportunities without discrimination because of race, creed, color, or national origin. Such action shall be taken with reference, but not limited to: recruitment, employment, job assignment, promotion, upgrading, demotion, transfer, layoff or termination, rates of pay or other forms of compensation, and selection for training or retraining, including apprenticeship and on-the-job training.
- b. The Contractor will send to each labor union or representative of workers with which he has or is bound by a collective bargaining or other agreement or understanding, a notice, to be provided by the Commission of Human Rights, advising such labor union or representative of the Contractor's agreement under clauses "a." through "h." hereinafter called "non-discrimination clauses", and requesting such labor union or representative to agree in writing, whether in such collective bargaining or other agreement or understanding or otherwise, that such labor union or representative will not discriminate against any member or applicant for membership because of race, creed, color, or national origin, and will take affirmative action to insure that they are afforded equal membership opportunities without discrimination because of race, creed, color, or national origin. Such action shall be taken with reference, but not be limited to: recruitment, employment, job assignment, promotion, upgrading, demotion, transfer, layoff or termination, rates of pay, or other forms of compensation, and selection for training or retraining including apprenticeship and on-the-job training. Such notice shall be given by the Contractor, and such written agreement shall be made by such labor union or representative, prior to the commencement of performances of this contract. If such labor union or representative fails or refuses so to agree in writing, the Contractor shall promptly notify the Commission for Human Rights of such failure or refusal.
- c. The Contractor will post and keep posted in conspicuous places, available to employees and applicants for employment, notices to be provided by the Commission for Human Rights setting forth the substance of the provisions of clauses "a." and "b." and such provisions of the State's Laws against discrimination as the Commission for Human Rights shall determine.
- d. The Contractor will state, in all solicitations or advertisements for employees placed by or on behalf of the Contractor, that all qualified applicants will be afforded equal employment opportunities without discrimination because of race, creed, color, or national origin.
- e. The Contractor will comply with the provisions of Sections 291-299 of the Executive Law and the Civil Rights Law, will furnish all information and reports deemed necessary by the Commission for Human Rights under these non-discrimination clauses and such sections of the Executive Law, and will, permit access to his books, records, and accounts by the Commission of Human Rights, and Owner representatives/counsel for purposes of investigation to ascertain compliance with these non-discrimination clauses and such sections of the Executive Law and Civil Rights Law.
- f. The Contract may be forthwith cancelled, terminated, or suspended in whole or in part, by the contracting agency upon the basis of a finding made by the Commission of Human Rights that the Contractor has not complied with these non-discrimination clauses, and the Contractor may be declared ineligible for future contracts made by or on the behalf of the Owner/Contracting Agency until he satisfied the Commission for Human Rights that he has established and is

carrying out a program in conformity with the provisions of these non-discrimination clauses. Such finding shall be made by the Commission for Human Rights after conciliation efforts by the Commission have failed to achieve compliance with these non-discrimination clauses and after a verified complaint has been filed with the Commission, notice thereof has been given to the Contractor and an opportunity has been afforded him to be heard publicly before three members of the Commission. Such sanctions may be imposed and remedies otherwise provided by law.

- g. If this Contract is cancelled or terminated under clause “f.”, in addition to other rights of the Owner provided in this contract upon its breach by the Contractor, the Contractor will hold the Owner harmless against any additional expenses or costs incurred by the Owner in completing the work or in purchasing the services, materials, equipment, or supplies contemplated by this contract, and the Owner may withhold payments from the Contractor in an amount sufficient for this purpose and recourse may be had against the surety on the performance bond if necessary.
- h. The Contractor will include the provisions of clauses “a.”, through “g.” in every subcontract or purchase order in such a manner that such provisions will be binding upon each subcontractor or vendor as to operations to be performed within jurisdictional locale of the Project being contracted by the Owner. The Contractor will take such action in enforcing such provisions of such subcontract or purchase as the Owner/Contracting Agency may direct, including sanctions or remedies for noncompliance. If the Contractor becomes involved in or is threatened with litigation with a subcontractor or vendor as a result of such direction by the Contracting Agency/Owner, the Contractor shall promptly so notify the Owner’s representatives/counsel, requesting him to intervene and protect the interests of the Owner (Contracting Agency’s jurisdictional area).



Kathy Hochul, Governor

Roberta Reardon, Commissioner

Village of Hastings-on-Hudson

Mary Head, Engineer
Putnam Business Park 1689
Route 22
Brewster NY 10509

Schedule Year 2022 through 2023
Date Requested 04/06/2023
PRC# 2023003965

Location Westchester County

Project ID#

Project Type The project consists of installing concrete curb, along with sidewalks, pavers, and asphalt.

PREVAILING WAGE SCHEDULE FOR ARTICLE 8 PUBLIC WORK PROJECT

Attached is the current schedule(s) of the prevailing wage rates and prevailing hourly supplements for the project referenced above. A unique Prevailing Wage Case Number (PRC#) has been assigned to the schedule(s) for your project.

The schedule is effective from July 2022 through June 2023. All updates, corrections, posted on the 1st business day of each month, and future copies of the annual determination are available on the Department's website www.labor.ny.gov. Updated PDF copies of your schedule can be accessed by entering your assigned PRC# at the proper location on the website.

It is the responsibility of the contracting agency or its agent to annex and make part, the attached schedule, to the specifications for this project, when it is advertised for bids and /or to forward said schedules to the successful bidder(s), immediately upon receipt, in order to insure the proper payment of wages.

Please refer to the "General Provisions of Laws Covering Workers on Public Work Contracts" provided with this schedule, for the specific details relating to other responsibilities of the Department of Jurisdiction.

Upon completion or cancellation of this project, enter the required information and mail **OR** fax this form to the office shown at the bottom of this notice, **OR** fill out the electronic version via the NYSDOL website.

NOTICE OF COMPLETION / CANCELLATION OF PROJECT

Date Completed: _____ Date Cancelled: _____

Name & Title of Representative: _____

Phone: (518) 457-5589 Fax: (518) 485-1870
W. Averell Harriman State Office Campus, Bldg. 12, Room 130, Albany, NY 12240

General Provisions of Laws Covering Workers on Article 8 Public Work Contracts

Introduction

The Labor Law requires public work contractors and subcontractors to pay laborers, workers, or mechanics employed in the performance of a public work contract not less than the prevailing rate of wage and supplements (fringe benefits) in the locality where the work is performed.

Responsibilities of the Department of Jurisdiction

A Department of Jurisdiction (Contracting Agency) includes a state department, agency, board or commission; a county, city, town or village; a school district, board of education or board of cooperative educational services; a sewer, water, fire, improvement and other district corporation; a public benefit corporation; and a public authority awarding a public work contract.

The Department of Jurisdiction (Contracting Agency) awarding a public work contract MUST obtain a Prevailing Rate Schedule listing the hourly rates of wages and supplements due the workers to be employed on a public work project. This schedule may be obtained by completing and forwarding a "Request for wage and Supplement Information" form (PW 39) to the Bureau of Public Work. The Prevailing Rate Schedule MUST be included in the specifications for the contract to be awarded and is deemed part of the public work contract.

Upon the awarding of the contract, the law requires that the Department of Jurisdiction (Contracting Agency) furnish the following information to the Bureau: the name and address of the contractor, the date the contract was let and the approximate dollar value of the contract. To facilitate compliance with this provision of the Labor Law, a copy of the Department's "Notice of Contract Award" form (PW 16) is provided with the original Prevailing Rate Schedule.

The Department of Jurisdiction (Contracting Agency) is required to notify the Bureau of the completion or cancellation of any public work project. The Department's PW 200 form is provided for that purpose.

Both the PW 16 and PW 200 forms are available for completion online.

Hours

No laborer, worker, or mechanic in the employ of a contractor or subcontractor engaged in the performance of any public work project shall be permitted to work more than eight hours in any day or more than five days in any week, except in cases of extraordinary emergency. The contractor and the Department of Jurisdiction (Contracting Agency) may apply to the Bureau of Public Work for a dispensation permitting workers to work additional hours or days per week on a particular public work project.

There are very few exceptions to this rule. Complete information regarding these exceptions is available on the "Request for a dispensation to work overtime" form (PW30) and "4 Day / 10 Hour Work Schedule" form (PW 30.1).

Wages and Supplements

The wages and supplements to be paid and/or provided to laborers, workers, and mechanics employed on a public work project shall be not less than those listed in the current Prevailing Rate Schedule for the locality where the work is performed. If a prime contractor on a public work project has not been provided with a Prevailing Rate Schedule, the contractor must notify the Department of Jurisdiction (Contracting Agency) who in turn must request an original Prevailing Rate Schedule form the Bureau of Public Work. Requests may be submitted by: mail to NYSDOL, Bureau of Public Work, State Office Bldg. Campus, Bldg. 12, Rm. 130, Albany, NY 12240; Fax to Bureau of Public Work (518) 485-1870; or electronically at the NYSDOL website www.labor.ny.gov.

Upon receiving the original schedule, the Department of Jurisdiction (Contracting Agency) is REQUIRED to provide complete copies to all prime contractors who in turn MUST, by law, provide copies of all applicable county schedules to each subcontractor and obtain from each subcontractor, an affidavit certifying such schedules were received. If the original schedule expired, the contractor may obtain a copy of the new annual determination from the NYSDOL website www.labor.ny.gov.

The Commissioner of Labor makes an annual determination of the prevailing rates. This determination is in effect from July 1st through June 30th of the following year. The annual determination is available on the NYSDOL website www.labor.ny.gov.

Payrolls and Payroll Records

Every contractor and subcontractor MUST keep original payrolls or transcripts subscribed and affirmed as true under penalty of perjury. As per Article 6 of the Labor law, contractors and subcontractors are required to establish, maintain, and preserve for not less than six (6) years, contemporaneous, true, and accurate payroll records. At a minimum, payrolls must show the following information for each person employed on a public work project: Name, Address, Last 4 Digits of Social Security Number, Classification(s) in which the worker was employed, Hourly wage rate(s) paid, Supplements paid

or provided, and Daily and weekly number of hours worked in each classification.

The filing of payrolls to the Department of Jurisdiction is a condition of payment. Every contractor and subcontractor shall submit to the Department of Jurisdiction (Contracting Agency), within thirty (30) days after issuance of its first payroll and every thirty (30) days thereafter, a transcript of the original payrolls, subscribed and affirmed as true under penalty of perjury. The Department of Jurisdiction (Contracting Agency) shall collect, review for facial validity, and maintain such payrolls.

In addition, the Commissioner of Labor may require contractors to furnish, with ten (10) days of a request, payroll records sworn to as their validity and accuracy for public work and private work. Payroll records include, but are not limited to time cards, work description sheets, proof that supplements were provided, cancelled payroll checks and payrolls. Failure to provide the requested information within the allotted ten (10) days will result in the withholding of up to 25% of the contract, not to exceed \$100,000.00. If the contractor or subcontractor does not maintain a place of business in New York State and the amount of the contract exceeds \$25,000.00, payroll records and certifications must be kept on the project worksite.

The prime contractor is responsible for any underpayments of prevailing wages or supplements by any subcontractor.

All contractors or their subcontractors shall provide to their subcontractors a copy of the Prevailing Rate Schedule specified in the public work contract as well as any subsequently issued schedules. A failure to provide these schedules by a contractor or subcontractor is a violation of Article 8, Section 220-a of the Labor Law.

All subcontractors engaged by a public work project contractor or its subcontractor, upon receipt of the original schedule and any subsequently issued schedules, shall provide to such contractor a verified statement attesting that the subcontractor has received the Prevailing Rate Schedule and will pay or provide the applicable rates of wages and supplements specified therein. (See NYS Labor Laws, Article 8 . Section 220-a).

Determination of Prevailing Wage and Supplement Rate Updates Applicable to All Counties

The wages and supplements contained in the annual determination become effective July 1st whether or not the new determination has been received by a given contractor. Care should be taken to review the rates for obvious errors. Any corrections should be brought to the Department's attention immediately. It is the responsibility of the public work contractor to use the proper rates. If there is a question on the proper classification to be used, please call the district office located nearest the project. Any errors in the annual determination will be corrected and posted to the NYSDOL website on the first business day of each month. Contractors are responsible for paying these updated rates as well, retroactive to July 1st.

When you review the schedule for a particular occupation, your attention should be directed to the dates above the column of rates. These are the dates for which a given set of rates is effective. To the extent possible, the Department posts rates in its possession that cover periods of time beyond the July 1st to June 30th time frame covered by a particular annual determination. Rates that extend beyond that instant time period are informational ONLY and may be updated in future annual determinations that actually cover the then appropriate July 1st to June 30th time period.

Withholding of Payments

When a complaint is filed with the Commissioner of Labor alleging the failure of a contractor or subcontractor to pay or provide the prevailing wages or supplements, or when the Commissioner of Labor believes that unpaid wages or supplements may be due, payments on the public work contract shall be withheld from the prime contractor in a sufficient amount to satisfy the alleged unpaid wages and supplements, including interest and civil penalty, pending a final determination.

When the Bureau of Public Work finds that a contractor or subcontractor on a public work project failed to pay or provide the requisite prevailing wages or supplements, the Bureau is authorized by Sections 220-b and 235.2 of the Labor Law to so notify the financial officer of the Department of Jurisdiction (Contracting Agency) that awarded the public work contract. Such officer MUST then withhold or cause to be withheld from any payment due the prime contractor on account of such contract the amount indicated by the Bureau as sufficient to satisfy the unpaid wages and supplements, including interest and any civil penalty that may be assessed by the Commissioner of Labor. The withholding continues until there is a final determination of the underpayment by the Commissioner of Labor or by the court in the event a legal proceeding is instituted for review of the determination of the Commissioner of Labor.

The Department of Jurisdiction (Contracting Agency) shall comply with this order of the Commissioner of Labor or of the court with respect to the release of the funds so withheld.

Summary of Notice Posting Requirements

The current Prevailing Rate Schedule must be posted in a prominent and accessible place on the site of the public work project. The prevailing wage schedule must be encased in, or constructed of, materials capable of withstanding adverse weather conditions and be titled "PREVAILING RATE OF WAGES" in letters no smaller than two (2) inches by two (2) inches.

The "Public Work Project" notice must be posted at the beginning of the performance of every public work contract, on each job site.

Every employer providing workers' compensation insurance and disability benefits must post notices of such coverage in the format prescribed by the Workers' Compensation Board in a conspicuous place on the jobsite.

Every employer subject to the NYS Human Rights Law must conspicuously post at its offices, places of employment, or employment training centers, notices furnished by the State Division of Human Rights.

Employers liable for contributions under the Unemployment Insurance Law must conspicuously post on the jobsite notices furnished by the NYS Department of Labor.

Apprentices

Employees cannot be paid apprentice rates unless they are individually registered in a program registered with the NYS Commissioner of Labor. The allowable ratio of apprentices to journeyworkers in any craft classification can be no greater than the statewide building trade ratios promulgated by the Department of Labor and included with the Prevailing Rate Schedule. An employee listed on a payroll as an apprentice who is not registered as above or is performing work outside the classification of work for which the apprentice is indentured, must be paid the prevailing journeyworker's wage rate for the classification of work the employee is actually performing.

NYSDOL Labor Law, Article 8, Section 220-3, require that only apprentices individually registered with the NYS Department of Labor may be paid apprenticeship rates on a public work project. No other Federal or State Agency of office registers apprentices in New York State.

Persons wishing to verify the apprentice registration of any person must do so in writing by mail, to the NYSDOL Office of Employability Development / Apprenticeship Training, State Office Bldg. Campus, Bldg. 12, Albany, NY 12240 or by Fax to NYSDOL Apprenticeship Training (518) 457-7154. All requests for verification must include the name and social security number of the person for whom the information is requested.

The only conclusive proof of individual apprentice registration is written verification from the NYSDOL Apprenticeship Training Albany Central office. Neither Federal nor State Apprenticeship Training offices outside of Albany can provide conclusive registration information.

It should be noted that the existence of a registered apprenticeship program is not conclusive proof that any person is registered in that program. Furthermore, the existence or possession of wallet cards, identification cards, or copies of state forms is not conclusive proof of the registration of any person as an apprentice.

Interest and Penalties

In the event that an underpayment of wages and/or supplements is found:

- Interest shall be assessed at the rate then in effect as prescribed by the Superintendent of Banks pursuant to section 14-a of the Banking Law, per annum from the date of underpayment to the date restitution is made.
- A Civil Penalty may also be assessed, not to exceed 25% of the total of wages, supplements, and interest due.

Debarment

Any contractor or subcontractor and/or its successor shall be ineligible to submit a bid on or be awarded any public work contract or subcontract with any state, municipal corporation or public body for a period of five (5) years when:

- Two (2) willful determinations have been rendered against that contractor or subcontractor and/or its successor within any consecutive six (6) year period.
- There is any willful determination that involves the falsification of payroll records or the kickback of wages or supplements.

Criminal Sanctions

Willful violations of the Prevailing Wage Law (Article 8 of the Labor Law) may be a felony punishable by fine or imprisonment of up to 15 years, or both.

Discrimination

No employee or applicant for employment may be discriminated against on account of age, race, creed, color, national origin, sex, disability or marital status.

No contractor, subcontractor nor any person acting on its behalf, shall by reason of race, creed, color, disability, sex or national origin discriminate against any citizen of the State of New York who is qualified and available to perform the work to which the employment relates (NYS Labor Law, Article 8, Section 220-e(a)).

No contractor, subcontractor, nor any person acting on its behalf, shall in any manner, discriminate against or intimidate any employee on account of race, creed, color, disability, sex, or national origin (NYS Labor Law, Article 8, Section 220-e(b)).

The Human Rights Law also prohibits discrimination in employment because of age, marital status, or religion.

There may be deducted from the amount payable to the contractor under the contract a penalty of \$50.00 for each calendar day during which such person was discriminated against or intimidated in violation of the provision of the contract (NYS Labor Law, Article 8, Section 220-e(c)).

The contract may be cancelled or terminated by the State or municipality. All monies due or to become due thereunder may be forfeited for a second or any subsequent violation of the terms or conditions of the anti-discrimination sections of the contract (NYS Labor Law, Article 8, Section 220-e(d)).

Every employer subject to the New York State Human Rights Law must conspicuously post at its offices, places of employment, or employment training centers notices furnished by the State Division of Human Rights.

Workers' Compensation

In accordance with Section 142 of the State Finance Law, the contractor shall maintain coverage during the life of the contract for the benefit of such employees as required by the provisions of the New York State Workers' Compensation Law.

A contractor who is awarded a public work contract must provide proof of workers' compensation coverage prior to being allowed to begin work.

The insurance policy must be issued by a company authorized to provide workers' compensation coverage in New York State. Proof of coverage must be on form C-105.2 (Certificate of Workers' Compensation Insurance) and must name this agency as a certificate holder.

If New York State coverage is added to an existing out-of-state policy, it can only be added to a policy from a company authorized to write workers' compensation coverage in this state. The coverage must be listed under item 3A of the information page.

The contractor must maintain proof that subcontractors doing work covered under this contract secured and maintained a workers' compensation policy for all employees working in New York State.

Every employer providing worker's compensation insurance and disability benefits must post notices of such coverage in the format prescribed by the Workers' Compensation Board in a conspicuous place on the jobsite.

Unemployment Insurance

Employers liable for contributions under the Unemployment Insurance Law must conspicuously post on the jobsite notices furnished by the New York State Department of Labor.



Kathy Hochul, Governor

Roberta Reardon, Commissioner

Village of Hastings-on-Hudson

Mary Head, Engineer
Putnam Business Park 1689
Route 22
Brewster NY 10509

Schedule Year 2022 through 2023
Date Requested 04/06/2023
PRC# 2023003965

Location Westchester County

Project ID#

Project Type The project consists of installing concrete curb, along with sidewalks, pavers, and asphalt.

Notice of Contract Award

New York State Labor Law, Article 8, Section 220.3a requires that certain information regarding the awarding of public work contracts, be furnished to the Commissioner of Labor. One "Notice of Contract Award" (PW 16, which may be photocopied), **MUST** be completed for **EACH** prime contractor on the above referenced project.

Upon notifying the successful bidder(s) of this contract, enter the required information and mail **OR** fax this form to the office shown at the bottom of this notice, **OR** fill out the electronic version via the NYSDOL website.

Contractor Information

All information must be supplied

| | | |
|---|--|------------|
| Federal Employer Identification Number: _____ | | |
| Name: _____ | | |
| Address: _____ _____ | | |
| City: _____ | State: _____ | Zip: _____ |
| Amount of Contract: \$ _____ | Contract Type: | |
| Approximate Starting Date: ____/____/____ | <input type="checkbox"/> (01) General Construction | |
| Approximate Completion Date: ____/____/____ | <input type="checkbox"/> (02) Heating/Ventilation | |
| | <input type="checkbox"/> (03) Electrical | |
| | <input type="checkbox"/> (04) Plumbing | |
| | <input type="checkbox"/> (05) Other : _____ | |

Phone: (518) 457-5589 Fax: (518) 485-1870
W. Averell Harriman State Office Campus, Bldg. 12, Room 130, Albany, NY 12240

Social Security Numbers on Certified Payrolls:

The Department of Labor is cognizant of the concerns of the potential for misuse or inadvertent disclosure of social security numbers. Identity theft is a growing problem and we are sympathetic to contractors' concern regarding inclusion of this information on payrolls if another identifier will suffice.

For these reasons, the substitution of the use of the last four digits of the social security number on certified payrolls submitted to contracting agencies on public work projects is now acceptable to the Department of Labor. This change does not affect the Department's ability to request and receive the entire social security number from employers during its public work/ prevailing wage investigations.

Construction Industry Fair Play Act: Required Posting for Labor Law Article 25-B § 861-d

Construction industry employers must post the "Construction Industry Fair Play Act" notice in a prominent and accessible place on the job site. Failure to post the notice can result in penalties of up to \$1,500 for a first offense and up to \$5,000 for a second offense. The posting is included as part of this wage schedule. Additional copies may be obtained from the NYS DOL website, <https://dol.ny.gov/public-work-and-prevailing-wage>

If you have any questions concerning the Fair Play Act, please call the State Labor Department toll-free at 1-866-435-1499 or email us at: dol.misclassified@labor.ny.gov .

Worker Notification: (Labor Law §220, paragraph a of subdivision 3-a)

Effective June 23, 2020

This provision is an addition to the existing wage rate law, Labor Law §220, paragraph a of subdivision 3-a. It requires contractors and subcontractors to provide written notice to all laborers, workers or mechanics of the *prevailing wage and supplement rate* for their particular job classification *on each pay stub**. It also requires contractors and subcontractors to *post a notice* at the beginning of the performance of every public work contract *on each job site* that includes the telephone number and address for the Department of Labor and a statement informing laborers, workers or mechanics of their right to contact the Department of Labor if he/she is not receiving the proper prevailing rate of wages and/or supplements for his/her job classification. The required notification will be provided with each wage schedule, may be downloaded from our website www.labor.ny.gov or be made available upon request by contacting the Bureau of Public Work at 518-457-5589. *In the event the required information will not fit on the pay stub, an accompanying sheet or attachment of the information will suffice.

(12.20)

**To all State Departments, Agency Heads and Public Benefit Corporations
IMPORTANT NOTICE REGARDING PUBLIC WORK ENFORCEMENT FUND**

Budget Policy & Reporting Manual

B-610

Public Work Enforcement Fund

effective date December 7, 2005

1. Purpose and Scope:

This Item describes the Public Work Enforcement Fund (the Fund, PWEF) and its relevance to State agencies and public benefit corporations engaged in construction or reconstruction contracts, maintenance and repair, and announces the recently-enacted increase to the percentage of the dollar value of such contracts that must be deposited into the Fund. This item also describes the roles of the following entities with respect to the Fund:

- New York State Department of Labor (DOL),
- The Office of the State of Comptroller (OSC), and
- State agencies and public benefit corporations.

2. Background and Statutory References:

DOL uses the Fund to enforce the State's Labor Law as it relates to contracts for construction or reconstruction, maintenance and repair, as defined in subdivision two of Section 220 of the Labor Law. State agencies and public benefit corporations participating in such contracts are required to make payments to the Fund.

Chapter 511 of the Laws of 1995 (as amended by Chapter 513 of the Laws of 1997, Chapter 655 of the Laws of 1999, Chapter 376 of the Laws of 2003 and Chapter 407 of the Laws of 2005) established the Fund.

3. Procedures and Agency Responsibilities:

The Fund is supported by transfers and deposits based on the value of contracts for construction and reconstruction, maintenance and repair, as defined in subdivision two of Section 220 of the Labor Law, into which all State agencies and public benefit corporations enter.

Chapter 407 of the Laws of 2005 increased the amount required to be provided to this fund to .10 of one-percent of the total cost of each such contract, to be calculated at the time agencies or public benefit corporations enter into a new contract or if a contract is amended. The provisions of this bill became effective August 2, 2005.

**To all State Departments, Agency Heads and Public Benefit Corporations
IMPORTANT NOTICE REGARDING PUBLIC WORK ENFORCEMENT FUND**

OSC will report to DOL on all construction-related ("D") contracts approved during the month, including contract amendments, and then DOL will bill agencies the appropriate assessment monthly. An agency may then make a determination if any of the billed contracts are exempt and so note on the bill submitted back to DOL. For any instance where an agency is unsure if a contract is or is not exempt, they can call the Bureau of Public Work at the number noted below for a determination. Payment by check or journal voucher is due to DOL within thirty days from the date of the billing. DOL will verify the amounts and forward them to OSC for processing.

For those contracts which are not approved or administered by the Comptroller, monthly reports and payments for deposit into the Public Work Enforcement Fund must be provided to the Administrative Finance Bureau at the DOL within 30 days of the end of each month or on a payment schedule mutually agreed upon with DOL.

Reports should contain the following information:

- Name and billing address of State agency or public benefit corporation;
- State agency or public benefit corporation contact and phone number;
- Name and address of contractor receiving the award;
- Contract number and effective dates;
- Contract amount and PWEF assessment charge (if contract amount has been amended, reflect increase or decrease to original contract and the adjustment in the PWEF charge); and
- Brief description of the work to be performed under each contract.

Checks and Journal Vouchers, payable to the "New York State Department of Labor" should be sent to:

Department of Labor
Administrative Finance Bureau-PWEF Unit
Building 12, Room 464
State Office Campus
Albany, NY 12240

Any questions regarding billing should be directed to NYSDOL's Administrative Finance Bureau-PWEF Unit at (518) 457-3624 and any questions regarding Public Work Contracts should be directed to the Bureau of Public Work at (518) 457-5589.

Required Notice under Article 25-B of the Labor Law

**Attention All Employees, Contractors and Subcontractors:
You are Covered by the Construction Industry Fair Play Act**

The law says that you are an employee unless:

- You are free from direction and control in performing your job, **and**
- You perform work that is not part of the usual work done by the business that hired you, **and**
- You have an independently established business.

Your employer cannot consider you to be an independent contractor unless all three of these facts apply to your work.

It is against the law for an employer to misclassify employees as independent contractors or pay employees off the books.

Employee Rights: If you are an employee, you are entitled to state and federal worker protections. These include:

- Unemployment Insurance benefits, if you are unemployed through no fault of your own, able to work, and otherwise qualified,
- Workers' compensation benefits for on-the-job injuries,
- Payment for wages earned, minimum wage, and overtime (under certain conditions),
- Prevailing wages on public work projects,
- The provisions of the National Labor Relations Act, and
- A safe work environment.

It is a violation of this law for employers to retaliate against anyone who asserts their rights under the law. Retaliation subjects an employer to civil penalties, a private lawsuit or both.

Independent Contractors: If you are an independent contractor, **you must pay all taxes and Unemployment Insurance contributions required by New York State and Federal Law.**

Penalties for paying workers off the books or improperly treating employees as independent contractors:

- **Civil Penalty** First offense: Up to \$2,500 per employee
 Subsequent offense(s): Up to \$5,000 per employee
- **Criminal Penalty** First offense: Misdemeanor - up to 30 days in jail, up to a \$25,000 fine and debarment from performing public work for up to one year.
 Subsequent offense(s): Misdemeanor - up to 60 days in jail or up to a \$50,000 fine and debarment from performing public work for up to 5 years.

If you have questions about your employment status or believe that your employer may have violated your rights and you want to file a complaint, call the Department of Labor at (866) 435-1499 or send an email to dol.misclassified@labor.ny.gov. All complaints of fraud and violations are taken seriously. You can remain anonymous.

Employer Name:

IA 999 (09/16)

Attention Employees

THIS IS A: **PUBLIC WORK PROJECT**

If you are employed on this project as a **worker, laborer, or mechanic** you are entitled to receive the **prevailing wage and supplements rate** for the classification at which you are working.

Chapter 629 of the Labor Laws of 2007:

These wages are set by law and must be posted at the work site. They can also be found at:

<https://dol.ny.gov/public-work-and-prevailing-wage>

If you feel that you have not received proper wages or benefits, please call our nearest office.*

| | | | |
|---------------|----------------|--------------|----------------|
| Albany | (518) 457-2744 | Patchogue | (631) 687-4882 |
| Binghamton | (607) 721-8005 | Rochester | (585) 258-4505 |
| Buffalo | (716) 847-7159 | Syracuse | (315) 428-4056 |
| Garden City | (516) 228-3915 | Utica | (315) 793-2314 |
| New York City | (212) 932-2419 | White Plains | (914) 997-9507 |
| Newburgh | (845) 568-5156 | | |

* For New York City government agency construction projects, please contact the Office of the NYC Comptroller at (212) 669-4443, or www.comptroller.nyc.gov – click on Bureau of Labor Law.

Contractor Name: _____

Project Location: _____

Requirements for OSHA 10 Compliance

Article 8 §220-h requires that when the advertised specifications, for every contract for public work, is \$250,000.00 or more the contract must contain a provision requiring that every worker employed in the performance of a public work contract shall be certified as having completed an OSHA 10 safety training course. The clear intent of this provision is to require that all employees of public work contractors, required to be paid prevailing rates, receive such training "prior to the performing any work on the project."

The Bureau will enforce the statute as follows:

All contractors and sub contractors must attach a copy of proof of completion of the OSHA 10 course to the first certified payroll submitted to the contracting agency and on each succeeding payroll where any new or additional employee is first listed.

Proof of completion may include but is not limited to:

- Copies of bona fide course completion card (*Note: Completion cards do not have an expiration date.*)
- Training roster, attendance record of other documentation from the certified trainer pending the issuance of the card.
- Other valid proof

**A certification by the employer attesting that all employees have completed such a course is not sufficient proof that the course has been completed.

Any questions regarding this statute may be directed to the New York State Department of Labor, Bureau of Public Work at 518-457-5589.

WICKS

Public work projects are subject to the Wicks Law requiring separate specifications and bidding for the plumbing, heating and electrical work, when the total project's threshold is \$3 million in Bronx, Kings, New York, Queens and, Richmond counties; \$1.5 million in Nassau, Suffolk and Westchester counties; and \$500,000 in all other counties.

For projects below the monetary threshold, bidders must submit a sealed list naming each subcontractor for the plumbing, HVAC and electrical and the amount to be paid to each. The list may not be changed unless the public owner finds a legitimate construction need, including a change in specifications or costs or the use of a Project Labor Agreement (PLA), and must be open to public inspection.

Allows the state and local agencies and authorities to waive the Wicks Law and use a PLA if it will provide the best work at the lowest possible price. If a PLA is used, all contractors shall participate in apprentice training programs in the trades of work it employs that have been approved by the Department of Labor (DOL) for not less than three years. They shall also have at least one graduate in the last three years and use affirmative efforts to retain minority apprentices. PLA's would be exempt from Wicks, but deemed to be public work subject to prevailing wage enforcement.

The Commissioner of Labor shall have the power to enforce separate specification requirements on projects, and may issue stop-bid orders against public owners for non-compliance.

Other new monetary thresholds, and similar sealed bidding for non-Wicks projects, would apply to certain public authorities including municipal housing authorities, NYC Construction Fund, Yonkers Educational Construction Fund, NYC Municipal Water Finance Authority, Buffalo Municipal Water Finance Authority, Westchester County Health Care Association, Nassau County Health Care Corp., Clifton-Fine Health Care Corp., Erie County Medical Center Corp., NYC Solid Waste Management Facilities, and the Dormitory Authority.

Contractors must pay subcontractors within a 7 days period.

(07.19)

Introduction to the Prevailing Rate Schedule

Information About Prevailing Rate Schedule

This information is provided to assist you in the interpretation of particular requirements for each classification of worker contained in the attached Schedule of Prevailing Rates.

Classification

It is the duty of the Commissioner of Labor to make the proper classification of workers taking into account whether the work is heavy and highway, building, sewer and water, tunnel work, or residential, and to make a determination of wages and supplements to be paid or provided. It is the responsibility of the public work contractor to use the proper rate. If there is a question on the proper classification to be used, please call the district office located nearest the project. District office locations and phone numbers are listed below.

Prevailing Wage Schedules are issued separately for "General Construction Projects" and "Residential Construction Projects" on a county-by-county basis.

General Construction Rates apply to projects such as: Buildings, Heavy & Highway, and Tunnel and Water & Sewer rates.

Residential Construction Rates generally apply to construction, reconstruction, repair, alteration, or demolition of one family, two family, row housing, or rental type units intended for residential use.

Some rates listed in the Residential Construction Rate Schedule have a very limited applicability listed along with the rate. Rates for occupations or locations not shown on the residential schedule must be obtained from the General Construction Rate Schedule. Please contact the local Bureau of Public Work office before using Residential Rate Schedules, to ensure that the project meets the required criteria.

Payrolls and Payroll Records

Contractors and subcontractors are required to establish, maintain, and preserve for not less than six (6) years, contemporaneous, true, and accurate payroll records.

Every contractor and subcontractor shall submit to the Department of Jurisdiction (Contracting Agency), within thirty (30) days after issuance of its first payroll and every thirty (30) days thereafter, a transcript of the original payrolls, subscribed and affirmed as true under penalty of perjury.

Paid Holidays

Paid Holidays are days for which an eligible employee receives a regular day's pay, but is not required to perform work. If an employee works on a day listed as a paid holiday, this remuneration is in addition to payment of the required prevailing rate for the work actually performed.

Overtime

At a minimum, all work performed on a public work project in excess of eight hours in any one day or more than five days in any workweek is overtime. However, the specific overtime requirements for each trade or occupation on a public work project may differ. Specific overtime requirements for each trade or occupation are contained in the prevailing rate schedules.

Overtime holiday pay is the premium pay that is required for work performed on specified holidays. It is only required where the employee actually performs work on such holidays.

The applicable holidays are listed under HOLIDAYS: OVERTIME. The required rate of pay for these covered holidays can be found in the OVERTIME PAY section listings for each classification.

Supplemental Benefits

Particular attention should be given to the supplemental benefit requirements. Although in most cases the payment or provision of supplements is straight time for all hours worked, some classifications require the payment or provision of supplements, or a portion of the supplements, to be paid or provided at a premium rate for premium hours worked. Supplements may also be required to be paid or provided on paid holidays, regardless of whether the day is worked. The Overtime Codes and Notes listed on the particular wage classification will indicate these conditions as required.

Effective Dates

When you review the schedule for a particular occupation, your attention should be directed to the dates above the column of rates. These are the dates for which a given set of rates is effective. The rate listed is valid until the next effective rate change or until the new annual determination which takes effect on July 1 of each year. All contractors and subcontractors are required to pay the current prevailing rates of wages and supplements. If you have any questions please contact the Bureau of Public Work or visit the New York State Department of Labor website (www.labor.ny.gov) for current wage rate information.

Apprentice Training Ratios

The following are the allowable ratios of registered Apprentices to Journey-workers.

For example, the ratio 1:1,1:3 indicates the allowable initial ratio is one Apprentice to one Journeyworker. The Journeyworker must be in place on the project before an Apprentice is allowed. Then three additional Journeyworkers are needed before a second Apprentice is allowed. The last ratio repeats indefinitely. Therefore, three more Journeyworkers must be present before a third Apprentice can be hired, and so on.

Please call Apprentice Training Central Office at (518) 457-6820 if you have any questions.

| Title (Trade) | Ratio |
|--|---------|
| Boilermaker (Construction) | 1:1,1:4 |
| Boilermaker (Shop) | 1:1,1:3 |
| Carpenter (Bldg.,H&H, Pile Driver/Dockbuilder) | 1:1,1:4 |
| Carpenter (Residential) | 1:1,1:3 |
| Electrical (Outside) Lineman | 1:1,1:2 |
| Electrician (Inside) | 1:1,1:3 |
| Elevator/Escalator Construction & Modernizer | 1:1,1:2 |
| Glazier | 1:1,1:3 |
| Insulation & Asbestos Worker | 1:1,1:3 |
| Iron Worker | 1:1,1:4 |
| Laborer | 1:1,1:3 |
| Mason | 1:1,1:4 |
| Millwright | 1:1,1:4 |
| Op Engineer | 1:1,1:5 |
| Painter | 1:1,1:3 |
| Plumber & Steamfitter | 1:1,1:3 |
| Roofer | 1:1,1:2 |
| Sheet Metal Worker | 1:1,1:3 |
| Sprinkler Fitter | 1:1,1:2 |

If you have any questions concerning the attached schedule or would like additional information, please contact the nearest BUREAU of PUBLIC WORK District Office or write to:

New York State Department of Labor
Bureau of Public Work
State Office Campus, Bldg. 12
Albany, NY 12240

| District Office Locations: | Telephone # | FAX # |
|--|--------------|--------------|
| Bureau of Public Work - Albany | 518-457-2744 | 518-485-0240 |
| Bureau of Public Work - Binghamton | 607-721-8005 | 607-721-8004 |
| Bureau of Public Work - Buffalo | 716-847-7159 | 716-847-7650 |
| Bureau of Public Work - Garden City | 516-228-3915 | 516-794-3518 |
| Bureau of Public Work - Newburgh | 845-568-5287 | 845-568-5332 |
| Bureau of Public Work - New York City | 212-932-2419 | 212-775-3579 |
| Bureau of Public Work - Patchogue | 631-687-4882 | 631-687-4902 |
| Bureau of Public Work - Rochester | 585-258-4505 | 585-258-4708 |
| Bureau of Public Work - Syracuse | 315-428-4056 | 315-428-4671 |
| Bureau of Public Work - Utica | 315-793-2314 | 315-793-2514 |
| Bureau of Public Work - White Plains | 914-997-9507 | 914-997-9523 |
| Bureau of Public Work - Central Office | 518-457-5589 | 518-485-1870 |

Westchester County General Construction

Boilermaker **04/01/2023**

JOB DESCRIPTION Boilermaker

DISTRICT 4

ENTIRE COUNTIES

Bronx, Dutchess, Kings, Nassau, New York, Orange, Putnam, Queens, Richmond, Rockland, Suffolk, Sullivan, Ulster, Westchester

WAGES

Per Hour: 07/01/2022

Boilermaker \$ 63.38
Repairs & Renovations 63.38

SUPPLEMENTAL BENEFITS

Per Hour:

Boilermaker 32% of hourly
Repair \$ Renovations Wage Paid
+ \$ 25.38

NOTE: "Hourly Wage Paid" shall include any and all premium(s) pay.

Repairs & Renovation Includes replacement of parts and repairs & renovation of existing unit.

OVERTIME PAY

See (D, O) on OVERTIME PAGE
Repairs & Renovation see (B,E,Q)

HOLIDAY

Paid: See (8, 16, 23, 24) on HOLIDAY PAGE
Overtime: See (5, 6, 8, 11, 12, 15, 16, 22, 23, 24, 25) on HOLIDAY PAGE

NOTE: *Employee must work in pay week to receive Holiday Pay.
**Employee gets 4 times the hourly wage rate for working Labor Day.

REGISTERED APPRENTICES

Wage per hour:
(1/2) Year Terms at the following percentage of Boilermaker's Wage

| 1st | 2nd | 3rd | 4th | 5th | 6th | 7th |
|-----|-----|-----|-----|-----|-----|-----|
| 65% | 70% | 75% | 80% | 85% | 90% | 95% |

Supplemental Benefits Per Hour:

Apprentice(s) 32% of Hourly
Wage Paid Plus
Amount Below

| | |
|----------|----------|
| 1st Term | \$ 19.41 |
| 2nd Term | 20.26 |
| 3rd Term | 21.11 |
| 4th Term | 21.96 |
| 5th Term | 22.82 |
| 6th Term | 23.68 |
| 7th Term | 24.52 |

NOTE: "Hourly Wage Paid" shall include any and all premium(s)

4-5

Carpenter **04/01/2023**

JOB DESCRIPTION Carpenter

DISTRICT 8

ENTIRE COUNTIES

Bronx, Kings, Nassau, New York, Putnam, Queens, Richmond, Rockland, Suffolk, Westchester

WAGES

Per hour: 07/01/2022

Piledriver \$ 58.16
+ 9.54*

Dockbuilder \$ 58.16
 + 9.54*

*This portion is not subject to overtime premiums

SUPPLEMENTAL BENEFITS

Per hour:

Journeyworker \$ 44.54

OVERTIME PAY

See (B, E2, O) on OVERTIME PAGE

HOLIDAY

Paid: See (1) on HOLIDAY PAGE.

Paid: for 1st & 2nd yr.

Apprentices See (5,6,11,13,25)

Overtime: See (5,6,11,13,25) on HOLIDAY PAGE.

REGISTERED APPRENTICES

Wages per hour

(1)year terms:

| | | | | |
|--|---------|---------|---------|---------|
| | 1st | 2nd | 3rd | 4th |
| | \$24.60 | \$30.20 | \$38.58 | \$46.97 |
| | + 5.05* | + 5.05* | + 5.05* | + 5.05* |

*This portion is not subject to overtime premiums

Supplemental benefits per hour:

All Terms: \$ 31.03

8-1556 Db

Carpenter

04/01/2023

JOB DESCRIPTION Carpenter

DISTRICT 8

ENTIRE COUNTIES

Bronx, Kings, Nassau, New York, Queens, Richmond, Rockland, Suffolk, Westchester

WAGES

Per hour: 07/01/2022

Carpet/Resilient

Floor Coverer \$ 55.05
 + 8.25*

*This portion is not subject to overtime premiums

INCLUDES HANDLING & INSTALLATION OF ARTIFICIAL TURF AND SIMILAR TURF INDOORS/OUTDOORS.

SUPPLEMENTAL BENEFITS

Per hour:

\$ 39.40

OVERTIME PAY

See (B, E, Q) on OVERTIME PAGE

HOLIDAY

Paid: See (18, 19) on HOLIDAY PAGE.

Paid for 1st & 2nd yr.

Apprentices See (5,6,11,13,16,18,19,25)

Overtime: See (5,6,11,13,16,18,19,25) on HOLIDAY PAGE.

REGISTERED APPRENTICES

Wage per hour - (1) year terms:

| | | | | |
|--|----------|----------|----------|----------|
| | 1st | 2nd | 3rd | 4th |
| | \$ 24.80 | \$ 27.80 | \$ 32.05 | \$ 39.93 |
| | + 1.85* | + 2.35* | + 2.85* | + 3.85* |

*This portion is not subject to overtime premiums

Supplemental benefits per hour:

| | | | | |
|--|----------|----------|----------|----------|
| | 1st | 2nd | 3rd | 4th |
| | \$ 14.80 | \$ 15.80 | \$ 18.90 | \$ 19.90 |

8-2287

Carpenter

04/01/2023

JOB DESCRIPTION Carpenter

DISTRICT 8

ENTIRE COUNTIES

Bronx, Dutchess, Kings, Nassau, New York, Orange, Putnam, Queens, Richmond, Rockland, Suffolk, Westchester

WAGES

Per Hour: 07/01/2022

Marine Construction:

Marine Diver \$ 73.03
 + 9.54*

Marine Tender \$ 62.11
 + 9.54*

*This portion is not subject to overtime premiums

SUPPLEMENTAL BENEFITS

Per Hour:

Journeyworker \$ 44.54

OVERTIME PAY

See (B, E, E2, Q) on OVERTIME PAGE

HOLIDAY

Paid: See (18, 19) on HOLIDAY PAGE

Overtime: See (5, 6, 10, 11, 13, 16, 18, 19) on HOLIDAY PAGE

REGISTERED APPRENTICES

Wages per hour:

One (1) year terms.

| | |
|----------|---------------------|
| 1st year | \$ 24.60 + 5.05* |
| 2nd year | 30.20 + 5.05* |
| 3rd year | 38.58 + 5.05* |
| 4th year | 56.97 + 5.05* |

*This portion is not subject to overtime premiums

Supplemental Benefits

Per Hour:

All terms \$ 31.03

8-1456MC

Carpenter

04/01/2023

JOB DESCRIPTION Carpenter

DISTRICT 8

ENTIRE COUNTIES

Bronx, Kings, Nassau, New York, Putnam, Queens, Richmond, Rockland, Suffolk, Westchester

WAGES

Per hour: 07/01/2022

Building \$ 57.80
 Millwright + 12.62*

*This portion is not subject to overtime premiums

SUPPLEMENTAL BENEFITS

Per hour:

Millwright \$ 43.16

OVERTIME PAY

See (B, E, Q) on OVERTIME PAGE

HOLIDAY

Paid: See (18,19) on HOLIDAY PAGE.

Overtime See (5,6,8,11,13,18,19,25) on HOLIDAY PAGE.

REGISTERED APPRENTICES

Wages per hour:

One (1) year terms:

| 1st. | 2nd. | 3rd. | 4th. |
|---------|---------|---------|----------|
| \$31.24 | \$36.69 | \$42.14 | \$53.04 |
| + 6.75* | + 7.92* | + 9.09* | + 11.43* |

*This portion is not subject to overtime premiums

Supplemental benefits per hour:

One (1) year terms:

| 1st. | 2nd. | 3rd. | 4th. |
|---------|---------|---------|---------|
| \$29.01 | \$31.54 | \$34.72 | \$39.14 |

8-740.1

Carpenter

04/01/2023

JOB DESCRIPTION Carpenter

DISTRICT 8

ENTIRE COUNTIES

Bronx, Kings, Nassau, New York, Queens, Richmond, Suffolk, Westchester

WAGES

Per Hour:

07/01/2022

Timberman \$ 53.05
+ 10.01*

*This portion not subject to overtime premiums

SUPPLEMENTAL BENEFITS

Per Hour:

07/01/2022

\$ 43.75

OVERTIME PAY

See (B, E, E2, Q) on OVERTIME PAGE

HOLIDAY

Paid: See (1) on HOLIDAY PAGE.

Paid: for 1st & 2nd yr.

Apprentices See (5,6,11,13,25)

Overtime: See (5,6,11,13,25) on HOLIDAY PAGE.

REGISTERED APPRENTICES

Wages per hour:

One (1) year terms:

| 1st | 2nd | 3rd | 4th |
|---------|---------|---------|---------|
| \$22.42 | \$27.53 | \$35.18 | \$42.84 |
| + 5.30* | + 5.30* | + 5.30* | +5.30* |

*This portion is not subject to overtime premiums

Supplemental benefits per hour:

All terms \$ 30.74

8-1556 Tm

Carpenter **04/01/2023**

JOB DESCRIPTION Carpenter

DISTRICT 8

ENTIRE COUNTIES

Bronx, Kings, Nassau, New York, Queens, Richmond, Rockland, Westchester

PARTIAL COUNTIES

Orange: South of but including the following, Waterloo Mills, Slate Hill, New Hampton, Goshen, Blooming Grove, Mountainville, east to the Hudson River.

Putnam: South of but including the following, Cold Spring, TompkinsCorner, Mahopac, Croton Falls, east to Connecticut border.

Suffolk: West of Port Jefferson and Patchogue Road to Route 112 to the Atlantic Ocean.

WAGES

Per hour: 07/01/2022 10/18/2022

Core Drilling:

| | | | |
|---------|----------|----------|--|
| Driller | \$ 42.27 | \$ 43.38 | |
| | + 2.30* | + 2.50* | |

Driller Helper

| | | | |
|--|---------|---------|--|
| | 33.47 | 34.47 | |
| | + 2.30* | + 2.50* | |

Note: Hazardous Waste Pay Differential:

For Level C, an additional 15% above wage rate per hour

For Level B, an additional 15% above wage rate per hour

For Level A, an additional 15% above wage rate per hour

Note: When required to work on water: an additional \$ 3.00 per hour.

*This portion is not subject to overtime premiums

SUPPLEMENTAL BENEFITS

Per hour:

| | | | |
|--------------------|----------|----------|--|
| Driller and Helper | \$ 28.30 | \$ 28.85 | |
|--------------------|----------|----------|--|

OVERTIME PAY

See (B, G, P) on OVERTIME PAGE

HOLIDAY

Paid: See (5, 6) on HOLIDAY PAGE

Overtime: See (5, 6) on HOLIDAY PAGE

8-1536-CoreDriller

Carpenter - Building / Heavy&Highway **04/01/2023**

JOB DESCRIPTION Carpenter - Building / Heavy&Highway

DISTRICT 11

ENTIRE COUNTIES

Putnam, Rockland, Westchester

WAGES

WAGES:(per hour)

Applies to CAPRENTER BUILDING/HEAVY & HIGHWAY/TUNNEL:

| | 07/01/2022 | 07/01/2023 | 07/01/2024 | 07/01/2025 |
|-----------|------------|------------|------------|------------|
| Base Wage | \$ 38.95 | \$ 1.25** | \$ 1.25** | \$ 1.25** |
| | +\$6.65* | | | |

*For all hours paid straight or premium.

**To be allocated at a later date.

SHIFT DIFFERENTIAL: When it is mandated by a Government Agency irregular or off shift can be worked. The Carpenter shall receive an additional fifteen percent (15%) of wage plus applicable benefits.

SUPPLEMENTAL BENEFITS

Per hour:

| | | |
|---------------|----------|--|
| Journeyworker | \$ 32.88 | |
|---------------|----------|--|

OVERTIME PAY

See (B, E, Q) on OVERTIME PAGE

HOLIDAY

BUILDING:

Paid: See (1) on HOLIDAY PAGE.
 Overtime: See (5, 6, 16, 25) on HOLIDAY PAGE.
 - Holidays that fall on Sunday will be observed Monday.

HEAVY&HIGHWAY/TUNNEL:

Paid: See (5, 6, 25) on HOLIDAY PAGE

Overtime: See (5, 6) on HOLIDAY PAGE

- Holidays that fall on Sunday will be observed Monday
 - Must be employed during the five (5) work days immediately preceding a holiday or during the five (5) work days following the paid holiday to receive holiday pay
 - If Employee is entitled to a paid holiday, the Employee is paid the Holiday wage and supplemental benefits whether they work or not. If Employee works the Holiday, the Employee will receive holiday pay (including supplemental benefits), plus the applicable premium wage for working the Holiday. If Employee works in excess of 8 hours on Holiday, then benefits will be paid for any hours in excess of 8 hours.

REGISTERED APPRENTICES

1 year terms at the following wage rates:

| 1st | 2nd | 3rd | 4th | 5th |
|----------|----------|----------|----------|----------|
| \$ 19.48 | \$ 23.37 | \$ 25.32 | \$ 27.27 | \$ 31.16 |
| +3.57* | +3.57* | +3.57* | +3.57* | +3.57* |

*For all hours paid straight or premium

SUPPLEMENTAL BENEFITS per hour:

All terms \$ 16.28

11-279.1B/HH

Electrician

04/01/2023

JOB DESCRIPTION Electrician

DISTRICT 9

ENTIRE COUNTIES

Bronx, Kings, New York, Queens, Richmond, Westchester

WAGES

| Per hour: | 07/01/2022 | 03/09/2023 |
|--------------------|------------|------------|
| Service Technician | \$ 35.40 | \$ 36.40 |

Service and Maintenance on Alarm and Security Systems.

Maintenance, repair and /or replacement of defective (or damaged) equipment on, but not limited to, Burglar - Fire - Security - CCTV - Card Access - Life Safety Systems and associated devices. (Whether by service contract of T&M by customer request.)

SUPPLEMENTAL BENEFITS

| Per hour: | | |
|----------------|----------|----------|
| Journeyworker: | \$ 20.18 | \$ 21.07 |

OVERTIME PAY

See (B, E, Q) on OVERTIME PAGE

HOLIDAY

Paid: See (5, 6, 11, 15, 16, 17, 25, 26) on HOLIDAY PAGE
 Overtime: See (5, 6, 11, 15, 16, 17, 25, 26) on HOLIDAY PAGE

9-3H

Electrician

04/01/2023

JOB DESCRIPTION Electrician

DISTRICT 8

ENTIRE COUNTIES

Westchester

WAGES

| Per hour: | 07/01/2022 |
|---------------------------|------------|
| *Electrician/A-Technician | \$ 53.75 |
| Teledata | 53.75 |

*Electrician/A-Technician \$ 53.75
 Teledata 53.75

*All new installations of wiring, conduit, junction boxes and light fixtures for projects with a base bid of more than \$325,000. For projects with a base bid of \$325,000 or less, see Maintenance and Repair rates.

Note: On a job where employees are required to work on bridges over navigable waters, transmission towers, light poles, bosun chairs, swinging scaffolds , etc. 40 feet or more above the water or ground or under compressed air, or tunnel projects under construction or where assisted breathing apparatus is required, they will be paid at the rate of time and one-half for such work except on normal pole line or building construction work.

SUPPLEMENTAL BENEFITS

Per hour:
 Journeyworker \$ 54.39

OVERTIME PAY

See (A, G, *J, P) on OVERTIME PAGE

*NOTE: Emergency work on Sunday and Holidays is at the time and one-half overtime rate.

HOLIDAY

Paid: See (1) on HOLIDAY PAGE
 Overtime: See (5, 6, 8, 11, 15, 16, 25) on HOLIDAY PAGE

REGISTERED APPRENTICES

(1) year terms at the following wage rates:

| | |
|------------------|------------|
| | 07/01/2022 |
| 1st term | \$ 15.00 |
| 2nd term | 16.00 |
| 3rd term | 18.00 |
| 4th term | 20.00 |
| MIJ 1-12 months | 25.00 |
| MIJ 13-18 months | 28.50 |

Supplemental Benefits per hour:

| | |
|------------------|------------|
| | 07/01/2022 |
| 1st term | \$ 10.82 |
| 2nd term | 13.05 |
| 3rd term | 14.39 |
| 4th term | 15.72 |
| MIJ 1-12 months | 13.49 |
| MIJ 13-18 months | 13.87 |

8-3/W

Electrician

04/01/2023

JOB DESCRIPTION Electrician

DISTRICT 8

ENTIRE COUNTIES

Westchester

WAGES

| | |
|----------------|------------|
| Per hour | 07/01/2022 |
| Electrician -M | \$ 28.50 |
| H - Telephone | 28.50 |

All work with a base bid amount of \$325,000 or less. Including repairs and /or replacement of defective electrical and teledata equipment, all work necessary to retrofit, service, maintain and repair all kinds of lighting fixtures and local lighting controls, and washing and cleaning of foregoing fixtures.

*If the project exceeds \$375,000 due to changes in the scope of work, an Electrician/A Technician must be part of the labor ratio.

SUPPLEMENTAL BENEFITS

| | |
|--------------------------------|------------|
| | 07/01/2022 |
| Electrician & H - Telephone | \$ 13.87 |

OVERTIME PAY

See (B, G, *J, P) on OVERTIME PAGE

*Note: Emergency work on Sunday and Holidays is at the time and one-half overtime rate.

HOLIDAY

Paid: See (1) on HOLIDAY PAGE
 Overtime: See (5, 6, 8, 11, 15, 16, 25) on HOLIDAY PAGE

8-3m

Elevator Constructor

04/01/2023

JOB DESCRIPTION Elevator Constructor

DISTRICT 4

ENTIRE COUNTIES

Bronx, Kings, Nassau, New York, Queens, Richmond, Suffolk

PARTIAL COUNTIES

Rockland: Entire County except for the Township of Stony Point

Westchester: Entire County except for the Townships of Bedford, Lewisboro, Cortland, Mt. Kisco, North Salem, Pound Ridge, Somers and Yorktown.

WAGES

Per hour:

07/01/2022 03/17/2023

Elevator Constructor \$ 75.14 \$ 77.49

Modernization & Service/Repair 59.09 60.89

Four(4), ten(10) hour days may be worked at straight time during a week, Monday thru Friday.

NOTE- In order to use the '4 Day/10 Hour Work Schedule', as your normal schedule, you must submit an 'Employer Registration for Use of 4 Day/10 Hour Work Schedule' form PW30.1; and there must be a dispensation of hours in place on the project. If the PW30.1 IS NOT SUBMITTED you will be liable for overtime payments for work over the allotted hours per day listed.

SUPPLEMENTAL BENEFITS

Per Hour:

Elevator Constructor \$ 43.914 \$ 45.574

Modernization & Service/Repairs 42.787 44.412

OVERTIME PAY

Constructor See (D, M, T) on OVERTIME PAGE.

Modern/Service See (B, F, S) on OVERTIME PAGE.

HOLIDAY

Paid: See (5, 6, 8, 11, 15, 16, 25) on HOLIDAY PAGE

Overtime: See (5, 6, 8, 11, 15, 16, 25) on HOLIDAY PAGE

REGISTERED APPRENTICES

WAGES PER HOUR:

*Note:1st, 2nd, 3rd Terms are based on Average wage of Constructor & Modernization.

Terms 4 thru 9 Based on Journeyman's wage of classification Working in.

6 MONTH TERMS:

| | | | | |
|------------------|------------------------|-----------------------|-----------------------|-----------------------|
| 1st Term* 50% | 2nd & 3rd Term* 50% | 4th & 5th Term 55% | 6th & 7th Term 65% | 8th & 9th Term 75% |
|------------------|------------------------|-----------------------|-----------------------|-----------------------|

SUPPLEMENTAL BENEFITS

Elevator Constructor

| | | |
|----------------|---------|---------|
| 1st Term | \$ 0.00 | \$ 0.00 |
| 2nd & 3rd Term | 34.772 | 36.024 |
| 4th & 5th Term | 35.606 | 36.943 |
| 6th & 7th Term | 37.052 | 38.448 |
| 8th & 9th Term | 38.497 | 39.953 |

Modernization & Service/Repair

| | | |
|----------------|---------|---------|
| 1st Term | \$ 0.00 | \$ 0.00 |
| 2nd & 3rd Term | 34.672 | 35.694 |
| 4th & 5th Term | 35.195 | 36.525 |
| 6th & 7th Term | 36.571 | 37.948 |
| 8th & 9th Term | 37.938 | 39.38 |

4-1

JOB DESCRIPTION Elevator Constructor

DISTRICT 1

ENTIRE COUNTIES

Columbia, Dutchess, Greene, Orange, Putnam, Sullivan, Ulster

PARTIAL COUNTIES

Delaware: Towns of Andes, Bovina, Colchester, Davenport, Delhi, Harpersfield, Hemdon, Kortright, Meredith, Middletown, Roxbury, Hancock & Stamford

Rockland: Only the Township of Stony Point.

Westchester: Only the Townships of Bedford, Lewisboro, Cortland, Mt. Kisco, North Salem, Pound Ridge, Somers and Yorktown.

WAGES

| | | |
|----------|------------------------------|------------------------------|
| Per Hour | 07/01/2022 | 01/01/2023 |
| Mechanic | \$ 64.63 | \$ 67.35 |
| Helper | 70% of Mechanic Wage Rate | 70% of Mechanic Wage Rate |

Four (4), ten (10) hour days may be worked for New Construction and Modernization Work at straight time during a week, Monday thru Thursday or Tuesday thru Friday.

***Four (4), ten (10) hour days are not permitted for Contract Work/Repair Work

NOTE - In order to use the '4 Day/10 Hour Work Schedule' as your normal schedule, you must submit an 'Employer Registration for Use of 4 Day/10 Hour Work Schedule', form PW30.1; and there must be a dispensation of hours in place on the project. If the PW30.1 is not submitted you may be liable for overtime payments for work over 8 hours per day.

SUPPLEMENTAL BENEFITS

| | | |
|-------------------|------------|------------|
| Per hour | 07/01/2022 | 01/01/2023 |
| Journeyman/Helper | \$ 36.885* | \$ 37.335* |

(*)Plus 6% of regular hourly if less than 5 years of service. Plus 8% of regular hourly rate if more than 5 years of service.

OVERTIME PAY

See (D, O) on OVERTIME PAGE

HOLIDAY

Paid: See (5, 6, 15, 16) on HOLIDAY PAGE

Overtime: See (5, 6, 15, 16) on HOLIDAY PAGE

Note: When a paid holiday falls on Saturday, it shall be observed on Friday. When a paid holiday falls on Sunday, it shall be observed on Monday.

REGISTERED APPRENTICES

| | | | | |
|-----------------|---------|--------|--------|--------|
| Wages per hour: | | | | |
| 0-6 mo* | 6-12 mo | 2nd yr | 3rd yr | 4th yr |
| 50 % | 55 % | 65 % | 70 % | 80 % |

(*)Plus 6% of the hourly rate, no additional supplemental benefits.

Supplemental Benefits per hour worked:

Same as Journeyman/Helper

1-138

Glazier

04/01/2023

JOB DESCRIPTION Glazier

DISTRICT 8

ENTIRE COUNTIES

Bronx, Dutchess, Kings, Nassau, New York, Orange, Putnam, Queens, Richmond, Rockland, Suffolk, Sullivan, Ulster, Westchester

WAGES

| | | |
|--------------------------------|-----------|------------|
| Per hour: | 7/01/2022 | 11/01/2022 |
| Glazier | \$ 59.59 | \$ 60.34 |
| *Scaffolding | 61.55 | 62.55 |
| Glass Tinting & Window Film | 30.11 | 30.11 |
| **Repair & Maintenance | 30.11 | 30.11 |

*Scaffolding includes swing scaffold, mechanical equipment, scissor jacks, man lifts, booms & buckets 24' or more, but not pipe scaffolding.

**Repair & Maintenance- All repair & maintenance work on a particular building whenever performed, where the total cumulative contract value is under \$148,837. All Glass tinting, window film, regardless of material or intended use, and all affixing of decals to windows or glass.

SUPPLEMENTAL BENEFITS

| Per hour: | 7/01/2022 | 11/01/2022 |
|----------------------|-----------|------------|
| Journeyworker | \$ 37.55 | \$ 38.05 |
| Glass tinting & | 22.01 | 22.01 |
| Window Film | | |
| Repair & Maintenance | 22.01 | 22.01 |

OVERTIME PAY

See (B,H,V) on OVERTIME PAGE.
 For 'Repair & Maintenance' see (B, B2, I, S) on overtime page.

HOLIDAY

Paid: See (1) on HOLIDAY PAGE
 Overtime: See (4, 6, 16, 25) on HOLIDAY PAGE

For 'Repair & Maintenance'

Paid: See(5, 6, 16, 25)

Overtime: See(5, 6, 16, 25)

REGISTERED APPRENTICES

Wage per hour:

(1) year terms at the following wage rates:

| | 7/01/2022 | 11/01/2022 |
|----------|-----------|------------|
| 1st term | \$ 21.15 | \$ 21.45 |
| 2nd term | 29.07 | 29.45 |
| 3rd term | 35.20 | 35.65 |
| 4th term | 47.38 | 47.98 |

Supplemental Benefits:

(Per hour)

| | | |
|----------|----------|----------|
| 1st term | \$ 17.15 | \$ 17.35 |
| 2nd term | 24.42 | 24.67 |
| 3rd term | 27.06 | 27.36 |
| 4th term | 32.15 | 32.55 |

8-1087 (DC9 NYC)

Insulator - Heat & Frost

04/01/2023

JOB DESCRIPTION Insulator - Heat & Frost

DISTRICT 8

ENTIRE COUNTIES

Dutchess, Orange, Putnam, Rockland, Westchester

WAGES

| Per hour: | 07/01/2022 | 05/31/2023 |
|---------------------------------------|------------|------------|
| Insulator | \$ 58.25 | + \$ 2.00 |
| Discomfort & Additional Training** | 61.30 | + \$ 2.00 |
| Fire Stop Work* | 31.15 | + \$ 2.00 |

* Applies on all exclusive Fire Stop Work (When contract is for Fire Stop work only). No apprentices on these contracts only.

**Applies to work requiring: garb or equipment worn against the body not customarily worn by insulators;psychological evaluation;special training, including but not limited to "Yellow Badge" radiation training

Note: Additional \$0.50 per hour for work 30 feet or more above floor or ground level.

SUPPLEMENTAL BENEFITS

Per hour:

Journeyworker \$ 36.10

Discomfort & Additional Training 38.09

Fire Stop Work:
 Journeyworker 18.41

OVERTIME PAY

See (B, E, E2, Q, *T) on OVERTIME PAGE

HOLIDAY

Paid: See (1) on HOLIDAY PAGE

Note: Last working day preceding Christmas and New Years day, workers shall work no later than 12:00 noon and shall receive 8 hrs pay.

Overtime: See (2*, 4, 6, 16, 25) on HOLIDAY PAGE.

*Note: Labor Day triple time if worked.

REGISTERED APPRENTICES

(1) year terms:

Insulator Apprentices:

| | | | |
|----------|----------|----------|----------|
| 1st | 2nd | 3rd | 4th |
| \$ 31.15 | \$ 36.56 | \$ 41.98 | \$ 47.41 |

Discomfort & Additional Training Apprentices:

| | | | |
|----------|----------|----------|----------|
| 1st | 2nd | 3rd | 4th |
| \$ 32.67 | \$ 38.39 | \$ 44.12 | \$ 49.85 |

Supplemental Benefits paid per hour:

Insulator Apprentices:

| | |
|----------|----------|
| 1st term | \$ 18.41 |
| 2nd term | 21.94 |
| 3rd term | 25.48 |
| 4th term | 29.03 |

Discomfort & Additional Training Apprentices:

| | |
|----------|----------|
| 1st term | \$ 19.41 |
| 2nd term | 23.14 |
| 3rd term | 26.88 |
| 4th term | 30.62 |

8-91

Ironworker

04/01/2023

JOB DESCRIPTION Ironworker

DISTRICT 9

ENTIRE COUNTIES

Bronx, Kings, Nassau, New York, Queens, Richmond, Suffolk, Westchester

WAGES

| | | |
|-------------------------|------------|------------|
| Per Hour: | 07/01/2022 | 01/01/2023 |
| | | Additional |
| Stone Derrickmen Rigger | \$ 72.26 | + \$ 1.64 |

| | | |
|-----------------------------|-------|-----------|
| Stone Handset Derrickman | 70.11 | + \$ 1.11 |
|-----------------------------|-------|-----------|

SUPPLEMENTAL BENEFITS

Per hour:

Stone Derrickmen Rigger \$ 42.10

Stone Handset
Derrickman 42.09

OVERTIME PAY

See (B, D1, *E, Q, **V) on OVERTIME PAGE

*Time and one-half shall be paid for all work on Saturday up to eight (8) hours and double time shall be paid for all work thereafter.

** Benefits same premium as wages on Holidays only

HOLIDAY

Paid: See (18) on HOLIDAY PAGE
 Overtime: See (5, 6, 8, 25) on HOLIDAY PAGE

Work stops at schedule lunch break with full day's pay.

REGISTERED APPRENTICES

Wage per hour:

Stone Derrickmen Rigger:

| | 1st | 2nd | 3rd | 4th |
|------------|----------|----------|----------|----------|
| 07/01/2022 | \$ 35.58 | \$ 50.89 | \$ 56.71 | \$ 62.48 |

Supplemental benefits:

| Per hour: | | | | |
|------------|-------|-------|-------|-------|
| 07/01/2022 | 21.61 | 31.97 | 31.97 | 31.97 |

Stone Handset:

1/2 year terms at the following hourly wage rate:

| | 1st | 2nd | 3rd | 4th |
|------------|-------|-------|-------|-------|
| 07/01/2022 | 34.50 | 49.43 | 54.99 | 61.00 |

Supplemental benefits:

| Per hour: | | | | |
|------------|-------|-------|-------|-------|
| 07/01/2022 | 21.60 | 31.96 | 31.96 | 31.96 |

9-197D/R

Ironworker

04/01/2023

JOB DESCRIPTION Ironworker

DISTRICT 4

ENTIRE COUNTIES

Bronx, Kings, Nassau, New York, Queens, Richmond, Suffolk, Westchester

WAGES

| Per Hour: | 07/01/2022 | 01/01/2023 |
|------------------|------------|------------|
| Ornamental | \$ 46.65 | \$ 46.90 |
| Chain Link Fence | 46.65 | 46.90 |
| Guide Rail | 46.65 | 46.90 |

SUPPLEMENTAL BENEFITS

| Per hour: | | |
|----------------|----------|----------|
| Journeyworker: | \$ 62.04 | \$ 63.04 |

OVERTIME PAY

See (B, B1, Q, V) on OVERTIME PAGE

HOLIDAY

Paid: See (1) on HOLIDAY PAGE
 Overtime: See (5, 6, 25) on HOLIDAY PAGE

REGISTERED APPRENTICES

Apprentices Hired after 9/1/18:

1 year terms

| | 07/01/2022 | 01/01/2023 |
|----------|------------|------------|
| 1st Term | \$ 20.63 | \$ 21.13 |
| 2nd Term | 24.22 | 24.77 |
| 3rd Term | 27.80 | 28.40 |
| 4th Term | 31.38 | 32.06 |

Supplemental Benefits per hour:

| 1st Term | \$ 17.90 | \$ 17.90 |
|----------|----------|----------|
| 2nd Term | 19.15 | 19.15 |
| 3rd Term | 20.41 | 20.41 |
| 4th Term | 21.67 | 21.67 |

4-580-Or

Ironworker

04/01/2023

JOB DESCRIPTION Ironworker

DISTRICT 4

ENTIRE COUNTIES

Bronx, Kings, Nassau, New York, Queens, Richmond, Suffolk, Westchester

WAGES

PER HOUR:

| | 07/01/2022 | 01/01/2023 |
|-------------|------------|------------|
| Ironworker: | | |
| Structural | \$ 55.70 | \$ 56.45 |
| Bridges | | |
| Machinery | | |

SUPPLEMENTAL BENEFITS

PER HOUR PAID:

| | | |
|------------|----------|----------|
| Journeyman | \$ 85.35 | \$ 86.35 |
|------------|----------|----------|

OVERTIME PAY

See (B, B1, Q, *V) on OVERTIME PAGE

*NOTE: Benefits are calculated for every hour paid

HOLIDAY

Paid: See (1) on HOLIDAY PAGE
 Overtime: See (5, 6, 18, 19) on HOLIDAY PAGE

REGISTERED APPRENTICES

WAGES PER HOUR:

6 month terms at the following rate:

| | | |
|-----------|----------|----------|
| 1st | \$ 28.97 | \$ 29.35 |
| 2nd | 29.57 | 29.95 |
| 3rd - 6th | 30.18 | 30.56 |

Supplemental Benefits

PER HOUR PAID:

| | | |
|-----------|----------|----------|
| All Terms | \$ 59.18 | \$ 59.94 |
|-----------|----------|----------|

4-40/361-Str

Ironworker

04/01/2023

JOB DESCRIPTION Ironworker

DISTRICT 4

ENTIRE COUNTIES

Bronx, Kings, Nassau, New York, Queens, Richmond, Suffolk, Westchester

PARTIAL COUNTIES

Rockland: Southern section - south of Convent Road and east of Blue Hills Road.

WAGES

| Per hour: | 07/01/2022 | 07/01/2023 |
|-----------------------------|--------------------------|--------------------|
| Reinforcing & Metal Lathing | \$ 56.90 | Additional \$ 1.50 |
| "Base" Wage | \$ 55.20 plus \$ 1.70 | |

"Base" Wage is used to calculate overtime hours only.

SUPPLEMENTAL BENEFITS

Per hour:

| | |
|-----------------------------|----------|
| Reinforcing & Metal Lathing | \$ 41.18 |
|-----------------------------|----------|

OVERTIME PAY

See (B, E, Q, *X) on OVERTIME PAGE

*Only \$23.50 per Hour for non worked hours

Supplemental Benefit Premiums for Overtime Hours worked:

| | |
|-----------------|----------|
| Time & One Half | \$ 47.68 |
| Double Time | \$ 54.18 |

HOLIDAY

Paid: See (1) on HOLIDAY PAGE
 Overtime: See (5, 6, 11, 13, *18, **19, 25) on HOLIDAY PAGE

*Note: Work performed after first 4 Hours.

REGISTERED APPRENTICES

(1) year terms at the following wage rates:

| 1st term | 2nd term | 3rd term | 4th Term |
|--|-------------------------|-------------------------|-------------------------|
| Wage Per Hour: \$ 22.55 | \$ 23.60 | \$ 24.60 | \$ 37.18 |
| "Base" Wage \$ 21.00 plus \$1.55 | \$ 22.00 plus \$1.60 | \$ 23.00 plus \$1.60 | \$ 35.60 plus \$1.58 |

"Base" Wage is used to calculate overtime hours ONLY.

SUPPLEMENTAL BENIFITS

Per Hour:

| 1st term | 2nd term | 3rd term | 4th Term |
|----------|----------|----------|----------|
| \$ 18.17 | \$ 17.17 | \$ 16.22 | \$ 22.50 |

4-46Reinf

Laborer - Building

04/01/2023

JOB DESCRIPTION Laborer - Building

DISTRICT 8

ENTIRE COUNTIES

Putnam, Westchester

WAGES

Per hour 07/01/2022

Laborer \$ 39.05
plus \$5.45**

Laborer - Asbestos & Hazardous
Materials Removal \$ 43.50*

* Abatement/Removal of:

- Lead based or lead containing paint on materials to be repainted is classified as Painter.
- Asbestos containing roofs and roofing material is classified as Roofer.

** This portion is not subject to overtime premium.

NOTE: Upgrade/Material condition work plan for work performed during non-outage under a wage formula of 90% wage/100% fringe benefits at nuclear power plants.

SUPPLEMENTAL BENEFITS

Per hour: 07/01/2022

Journeyworker \$ 29.50

OVERTIME PAY

See (B, E, E2, Q, *V) on OVERTIME PAGE

*Note: For Sundays and Holidays worked benefits are at the same premium as wages.

HOLIDAY

Paid: See (1) on HOLIDAY PAGE
 Overtime: See (5, 6, 16, 25) on HOLIDAY PAGE

REGISTERED APPRENTICES

LABORER ONLY

Hourly terms at the following wage:

| Level A 0-1000 | Level B 1001-2000 | Level C 2001-3000 | Level D 3001-4000 |
|-------------------|----------------------|----------------------|----------------------|
| \$ 27.07 | \$ 30.89 | \$ 34.72 | \$ 38.54 |

Supplemental Benefits per hour:

Apprentices
All terms \$ 22.20

Laborer - Heavy&Highway

04/01/2023

JOB DESCRIPTION Laborer - Heavy&Highway

DISTRICT 8

ENTIRE COUNTIES

Putnam, Westchester

WAGES

****PUTNAM: APPLIES TO ALL HEAVY & HIGHWAY WORK EXCLUDING HIGHWAYS, STREETS, AND BRIDGES****

GROUP I: Blaster, Quarry Master, Curbs/Asphalt Screedman, Pipe Jacking and Boring Operations Operator, Qualified Dead Condition Pipe Fuser (B Mechanic)

GROUP II: Burner, Drillers(jumbo, joy, wagon, air track, hydraulic), Drill Operator, Self Contained Rotary Drill, Curbs, Raker, Bar Person, Concrete Finisher.

GROUP III: Pavement Breakers, Jeeper Operator, Jack Hammer, Pneumatic Tools (all), Gas Driller, Guniting, Railroad Spike Puller, Pipelayer, Chain Saw, Deck winches on scows, Power Buggy Operator, Power Wheelbarrow Operator, Bar Person Helper, Compressed Air lance, Water Jet Lance.

GROUP IV: Concrete Laborers, Asph. Worker, Rock Scaler, Vibrator Oper., Bit Grinder, Air Tamper, Pumps, Epoxy (adhesives, fillers and troweled on), Barco Rammer, Concrete Grinder, Crack Router Operator, Guide Rail-digging holes and placing concrete and demolition when not to be replaced, distribution of materials and tightening of bolts.

GROUP V: Drillers Helpers, Common Laborer, Mason Tenders, Signal Person, Pit Person, Truck Spotter, Powder Person, Landscape/Nursery Person, Dump Person, Temp. Heat.

GROUP VIA: Asbestos/Toxic Waste Laborer-All removal (Roads, Tunnels, Landfills, etc.) Confined space laborer, Bio-remediation, Phyto-remediation, Lead or Hazardous material, Abatement Laborer.

Wages:(per hour) 07/01/2022

| | |
|----------------------|-----------|
| GROUP I | \$ 47.13* |
| GROUP II | 45.78* |
| GROUP III | 45.38* |
| GROUP IV | 45.03* |
| GROUP V | 44.68* |
| GROUP VIA | 46.68* |
| Operator Qualified | |
| Gas Mechanic(A Mech) | 57.13* |
| Flagperson | 38.33* |

*NOTE: To calculate overtime premiums, deduct \$0.10 from above wages

SHIFT WORK: A shift premium will be paid on Public Work contracts for off-shift or irregular shift work when mandated by the NYS D.O.T. or other Governmental Agency contracts. Employees shall receive an additional 15% per hour above current rate for all regular and irregular shift work. Premium pay shall be calculated using the 15% per hour differential as base rate.

SUPPLEMENTAL BENEFITS

Per hour:

Journeyworker:

| | |
|----------------|----------|
| First 40 Hours | |
| Per Hour | \$ 26.82 |
| Over 40 Hours | |
| Per Hour | 20.32 |

OVERTIME PAY

See (B, E, P, R, S) on OVERTIME PAGE

HOLIDAY

Paid: See (5, 6, 8, 15, 25, 26) on HOLIDAY PAGE

Overtime: See (5, 6, 8, 15, 25, 26) on HOLIDAY PAGE

NOTE: For Holiday Overtime: 5, 6 - Code 'S' applies
 For Holiday Overtime: 8, 15, 25, 26 - Code 'R' applies

REGISTERED APPRENTICES

| | 1st term | 2nd term | 3rd term | 4th term |
|------------|-----------|--------------|--------------|--------------|
| | 1-1000hrs | 1001-2000hrs | 2001-3000hrs | 3001-4000hrs |
| 07/01/2022 | \$ 25.37 | \$ 29.94 | \$ 34.51 | \$ 38.98 |

Supplemental Benefits per hour:

| | |
|----------|-----------------------------------|
| 1st term | \$ 4.70 - After 40 hours: \$ 4.45 |
| 2nd term | \$ 4.80 - After 40 hours: 4.45 |
| 3rd term | \$ 5.30 - After 40 hours: 4.85 |
| 4th term | \$ 5.85 - After 40 hours: 5.35 |

8-60H/H

Laborer - Tunnel

04/01/2023

JOB DESCRIPTION Laborer - Tunnel

DISTRICT 11

ENTIRE COUNTIES

Columbia, Dutchess, Greene, Orange, Otsego, Putnam, Rockland, Sullivan, Ulster, Westchester

PARTIAL COUNTIES

Chenango: Townships of Columbus, Sherburne and New Berlin.

Delaware: Townships of Andes, Bovina, Middletown, Roxbury, Franklin, Hamden, Stamford, Delhi, Kortright, Harpersfield, Merideth and Davenport.

WAGES

Class 1: All support laborers/sandhogs working above the shaft or tunnel.

Class 2: All laborers/sandhogs working in the shaft or tunnel.

Class 4: Safety Miners

Class 5: Site work related to Shaft/Tunnel

WAGES: (per hour)

| | |
|---------|------------|
| | 07/01/2022 |
| Class 1 | \$ 53.45 |
| Class 2 | 55.60 |
| Class 4 | 62.00 |
| Class 5 | 44.80 |

Toxic and hazardous waste, lead abatement and asbestos abatement work will be paid an additional \$ 3.00 an hour.

SHIFT DIFFERENTIAL...On all Government mandated irregular shift work:

- Employee shall be paid at time and one half the regular rate Monday through Friday.
- Saturday shall be paid at 1.65 times the regular rate.
- Sunday shall be paid at 2.15 times the regular rate.

SUPPLEMENTAL BENEFITS

Per hour:

| | |
|-----------|----------|
| Benefit 1 | \$ 34.45 |
| Benefit 2 | 51.60 |
| Benefit 3 | 68.75 |

Benefit 1 applies to straight time hours, paid holidays not worked.

Benefit 2 applies to over 8 hours in a day (M-F), irregular shift work hours worked, and Saturday hours worked.

Benefit 3 applies to Sunday and Holiday hours worked.

OVERTIME PAY

See (B, E, Q, X) on OVERTIME PAGE

HOLIDAY

Paid: See (5, 6, 15, 25) on HOLIDAY PAGE

Overtime: See (5, 6, 15, 16, 25) on HOLIDAY PAGE

When a recognized Holidays falls on Saturday or Sunday, holidays falling on Saturday shall be recognized or observed on Friday and holidays falling on Sunday shall be recognized or observed on Monday. Employees ordered to work on the Saturday or Sunday of the holiday or on the recognized or the observed Friday or Monday for those holidays falling on Saturday or Sunday shall receive double time the established rate and benefits for the holiday.

REGISTERED APPRENTICES

FOR APPRENTICE RATES, refer to the appropriate Laborer Heavy & Highway wage rate contained in the wage schedule for the County and location where the work is to be performed.

11-17/60/235/754Tun

Lineman Electrician

04/01/2023

JOB DESCRIPTION Lineman Electrician

DISTRICT 6

ENTIRE COUNTIES

Westchester

WAGES

A Lineman/Technician shall perform all overhead aerial work. A Lineman/Technician on the ground will install all electrical panels, connect all grounds, install and connect all electrical conductors, assembly of all electrical materials, conduit, pipe or raceway; placing of fish wire; pulling of cables, wires or fiber optic cable through such raceways; splicing of conductors; dismantling of such structures, lines or equipment.

A Groundman/Truck Driver shall: Build and set concrete forms, handle steel mesh, set footer cages, transport concrete in a wheelbarrow, hand or machine concrete vibrator, finish concrete footers, mix mortar, grout pole bases, cover and maintain footers while curing in cold weather, operate jack hammer, operate hand pavement breaker, tamper, concrete and other motorized saws, as a drill helper, operate and maintain generators, water pumps, chainsaws, sand blasting, operate mulching and seeding machine, air tools, electric tools, gas tools, load and unload materials, hand shovel and/or broom, prepare and pour mastic and other fillers, assist digger operator equipment/operator in ground excavation and restoration, landscape work and painting. Only when assisting a lineman technician, a groundman/truck driver may assist in installing conduit, pipe, cables and equipment.

Below rates apply to electrical overhead and underground distribution and maintenance work and overhead and underground transmission line work, electrical substations, switching structures, continuous pipe-type underground fluid or gas filled transmission conduit and cable installations, maintenance jobs or projects, railroad catenary installations and maintenance, third rail installations, the bonding of rails and the installation of fiber optic cable. (Ref #14.04.01)

NOTE: Includes Teledata Work within ten (10) feet of High Voltage Transmission Lines. Also includes digging of holes for poles, anchors, footer, and foundations for electrical equipment.

| Per hour: | 07/01/2022 | 05/01/2023 | 05/06/2024 |
|-------------------------|------------|------------|------------|
| Lineman, Tech, Welder | \$ 59.01 | \$ 60.41 | \$ 61.91 |
| Crane, Crawler Backhoe | 59.01 | 60.41 | 61.91 |
| Cable Splicer-Pipe Type | 64.91 | 66.45 | 68.10 |
| Digging Mach Operator | 53.11 | 54.37 | 55.72 |
| Cert. Welder-Pipe Type | 61.96 | 63.43 | 65.01 |
| Tractor Trailer Driver | 50.16 | 51.35 | 52.62 |
| Groundman, Truck Driver | 47.21 | 48.33 | 49.53 |
| Equipment Mechanic | 47.21 | 48.33 | 49.53 |
| Flagman | 35.41 | 36.25 | 37.15 |

Additional \$1.00 per hour for entire crew when a helicopter is used.

NOTE: THE FOLLOWING RATES WILL APPLY ON ALL CONTRACTING AGENCY MANDATED MULTIPLE SHIFTS OF AT LEAST FIVE (5) DAYS DURATION WORKED BETWEEN THE HOURS LISTED BELOW:

| | |
|-----------|---|
| 1ST SHIFT | 8:00 AM TO 4:30 PM REGULAR RATE |
| 2ND SHIFT | 4:30 PM TO 1:00 AM REGULAR RATE PLUS 17.3% |
| 3RD SHIFT | 12:30 AM TO 9:00 AM REGULAR RATE PLUS 31.4% |

Four (4), ten (10) hour days may be worked at straight time during a week, Monday thru Thursday. Friday may be used as a make-up day. Tuesday thru Friday may be worked with no make-up day.

NOTE - In order to use the '4 Day/10 Hour Work schedule', as your normal schedule, you must submit an 'Employer Registration for Use of 4 Day/10 Hour Work Schedule,' form PW30.1; and there must be a dispensation of hours in place on the project. If the PW30.1 is not submitted you may be liable for overtime payments for work over 8 hours per day.

SUPPLEMENTAL BENEFITS

Per hour worked (but also required on non-worked holidays):

| | 07/01/2022 | 05/01/2023 | 05/06/2024 |
|--|--|--|--|
| Journeyman | \$ 25.90 *plus 7% of the hourly wage paid | \$ 26.40 *plus 7% of the hourly wage paid | \$ 26.90 *plus 7% of the hourly wage paid |
| Journeyman Lineman or Equipment Operators with Crane License | \$ 27.90 *plus 7% of the hourly wage paid | \$ 29.40 *plus 7% of the hourly wage paid | \$ 30.90 *plus 7% of the hourly wage paid |

*The 7% is based on the hourly wage paid, straight time or premium time.

OVERTIME PAY

See (B, E, Q,) on OVERTIME PAGE. *Note* Double time for emergency work designated by the Dept of Jurisdiction.

NOTE: WAGE CAP - Double the straight time hourly base wage shall be the maximum hourly wage compensation for any hour worked. Contractor is still responsible to pay the hourly benefit amount for each hour worked.

HOLIDAY

Paid See (5, 6, 8, 13, 25) on HOLIDAY PAGE plus Governor of NYS Election Day.
 Overtime See (5, 6, 8, 13, 25) on HOLIDAY PAGE plus Governor of NYS Election Day.

NOTE: All paid holidays falling on Saturday shall be observed on the preceding Friday. All paid holidays falling on Sunday shall be observed on the following Monday. Supplements for holidays paid at straight time.

REGISTERED APPRENTICES

WAGES per hour: 1000 hour terms at the following percentage of the applicable Journeyman Lineman wage.

| | | | | | | |
|-----|-----|-----|-----|-----|-----|-----|
| 1st | 2nd | 3rd | 4th | 5th | 6th | 7th |
| 60% | 65% | 70% | 75% | 80% | 85% | 90% |

SUPPLEMENTAL BENEFITS per hour:

| | | |
|----------------------------------|----------------------------------|----------------------------------|
| 07/01/2022 | 05/01/2023 | 05/06/2024 |
| \$ 25.90 | \$ 26.40 | \$ 26.90 |
| *plus 7% of the hourly wage paid | *plus 7% of the hourly wage paid | *plus 7% of the hourly wage paid |

*The 7% is based on the hourly wage paid, straight time or premium time.

6-1249aWest

Lineman Electrician - Teledata

04/01/2023

JOB DESCRIPTION Lineman Electrician - Teledata

DISTRICT 6

ENTIRE COUNTIES

Albany, Allegany, Broome, Cattaraugus, Cayuga, Chautauqua, Chemung, Chenango, Clinton, Columbia, Cortland, Delaware, Dutchess, Erie, Essex, Franklin, Fulton, Genesee, Greene, Hamilton, Herkimer, Jefferson, Lewis, Livingston, Madison, Monroe, Montgomery, Niagara, Oneida, Onondaga, Ontario, Orange, Orleans, Oswego, Otsego, Putnam, Rensselaer, Rockland, Saratoga, Schenectady, Schoharie, Schuyler, Seneca, St. Lawrence, Steuben, Sullivan, Tioga, Tompkins, Ulster, Warren, Washington, Wayne, Westchester, Wyoming, Yates

WAGES

Per hour:

For outside work, stopping at first point of attachment (demarcation).

| | | | | |
|------------------------|------------|------------|------------|------------|
| | 07/01/2022 | 01/01/2023 | 01/01/2024 | 01/01/2025 |
| Cable Splicer | \$ 36.28 | \$ 37.73 | \$ 39.24 | \$ 40.81 |
| Installer, Repairman | \$ 34.43 | \$ 35.81 | \$ 37.24 | \$ 38.73 |
| Teledata Lineman | \$ 34.43 | \$ 35.81 | \$ 37.24 | \$ 38.73 |
| Tech., Equip. Operator | \$ 34.43 | \$ 35.81 | \$ 37.24 | \$ 38.73 |
| Groundman | \$ 18.25 | \$ 18.98 | \$ 19.74 | \$ 20.53 |

NOTE: EXCLUDES Teledata work within ten (10) feet of High Voltage (600 volts and over) transmission lines. For this work please see LINEMAN.

NOTE: THE FOLLOWING RATES WILL APPLY ON ALL CONTRACTING AGENCY MANDATED MULTIPLE SHIFTS OF AT LEAST FIVE (5) DAYS DURATION WORKED:

| | |
|-----------|-----------------------|
| 1ST SHIFT | REGULAR RATE |
| 2ND SHIFT | REGULAR RATE PLUS 10% |
| 3RD SHIFT | REGULAR RATE PLUS 15% |

SUPPLEMENTAL BENEFITS

| | | | | |
|------------|----------------------------------|----------------------------------|----------------------------------|----------------------------------|
| Per hour: | 07/01/2022 | 01/01/2023 | 01/01/2024 | 01/01/2025 |
| Journeyman | \$ 5.14 | \$ 5.14 | \$ 5.14 | \$ 5.14 |
| | *plus 3% of the hourly wage paid | *plus 3% of the hourly wage paid | *plus 3% of the hourly wage paid | *plus 3% of the hourly wage paid |

*The 3% is based on the hourly wage paid, straight time rate or premium rate.

OVERTIME PAY

See (B, E, Q) on OVERTIME PAGE

NOTE: WAGE CAP - Double the straight time hourly base wage shall be the maximum hourly wage compensation for any hour worked.
 Contractor is still responsible to pay the hourly benefit amount for each hour worked.

HOLIDAY

Paid: See (1) on HOLIDAY PAGE
 Overtime: See (5, 6, 16) on HOLIDAY PAGE

6-1249LT - Teledata

Lineman Electrician - Traffic Signal, Lighting

04/01/2023

JOB DESCRIPTION Lineman Electrician - Traffic Signal, Lighting

DISTRICT 6

ENTIRE COUNTIES

Westchester

WAGES

Lineman/Technician shall perform all overhead aerial work. A Lineman/Technician on the ground will install all electrical panels, connect all grounds, install and connect all electrical conductors which includes, but is not limited to road loop wires; conduit and plastic or other type pipes that carry conductors, flex cables and connectors, and to oversee the encasement or burial of such conduits or pipes.

A Groundman/Groundman Truck Driver shall: Build and set concrete forms, handle steel mesh, set footer cages, transport concrete in a wheelbarrow, hand or machine concrete vibrator, finish concrete footers, mix mortar, grout pole bases, cover and maintain footers while curing in cold weather, operate jack hammer, operate hand pavement breaker, tamper, concrete and other motorized saws, as a drill helper, operate and maintain generators, water pumps, chainsaws, sand blasting, operate mulching and seeding machine, air tools, electric tools, gas tools, load and unload materials, hand shovel and/or broom, prepare and pour mastic and other fillers, assist digger operator/equipment operator in ground excavation and restoration, landscape work and painting. Only when assisting a lineman technician, a groundman/truck driver may assist in installing conduit, pipe, cables and equipment.

A flagger's duties shall consist of traffic control only.
 (Ref #14.01.03)

| Per hour: | 07/01/2022 | 05/01/2023 | 05/06/2024 |
|-------------------------|------------|------------|------------|
| Lineman, Technician | \$ 53.60 | \$ 54.73 | \$ 55.95 |
| Crane, Crawler Backhoe | 53.60 | 54.73 | 55.95 |
| Certified Welder | 56.28 | 57.47 | 58.75 |
| Digging Machine | 48.24 | 49.26 | 50.36 |
| Tractor Trailer Driver | 45.56 | 46.52 | 47.56 |
| Groundman, Truck Driver | 42.88 | 43.78 | 44.76 |
| Equipment Mechanic | 42.88 | 43.78 | 44.76 |
| Flagman | 32.16 | 32.84 | 33.57 |

Above rates are applicable for installation, testing, operation, maintenance and repair on all Traffic Control (Signal) and Illumination (Lighting) projects, Traffic Monitoring Systems, and Road Weather Information Systems. Includes digging of holes for poles, anchors, footer foundations for electrical equipment; assembly of all electrical materials or raceway; placing of fish wire; pulling of cables, wires or fiber optic cable through such raceways; splicing of conductors; dismantling of such structures, lines or equipment.

NOTE: THE FOLLOWING RATES WILL APPLY ON ALL CONTRACTING AGENCY MANDATED MULTIPLE SHIFTS OF AT LEAST FIVE (5) DAYS DURATION WORKED BETWEEN THE HOURS LISTED BELOW:

| | |
|-----------|---|
| 1ST SHIFT | 8:00 AM TO 4:30 PM REGULAR RATE |
| 2ND SHIFT | 4:30 PM TO 1:00 AM REGULAR RATE PLUS 17.3% |
| 3RD SHIFT | 12:30 AM TO 9:00 AM REGULAR RATE PLUS 31.4% |

Four (4), ten (10) hour days may be worked at straight time during a week, Monday thru Thursday. Friday may be used as a make-up day. Tuesday thru Friday may be worked with no make-up day.

NOTE - In order to use the '4 Day/10 Hour Work schedule', as your normal schedule, you must submit an 'Employer Registration for Use of 4 Day/10 Hour Work Schedule,' form PW30.1; and there must be a dispensation of hours in place on the project. If the PW30.1 is not submitted you may be liable for overtime payments for work over 8 hours per day.

SUPPLEMENTAL BENEFITS

Per hour worked (but also required on non-worked holidays):

| | 07/01/2022 | 05/01/2023 | 05/06/2024 |
|------------|----------------------------------|----------------------------------|----------------------------------|
| Journeyman | \$ 25.90 | \$ 26.40 | \$ 26.90 |
| | *plus 7% of the hourly wage paid | *plus 7% of the hourly wage paid | *plus 7% of the hourly wage paid |

| | | | |
|--|--|--|--|
| Journeyman Lineman or Equipment Operators with Crane License | \$ 27.90 *plus 7% of the hourly wage paid | \$ 29.40 *plus 7% of the hourly wage paid | \$ 30.90 *plus 7% of the hourly wage paid |
|--|--|--|--|

*The 7% is based on the hourly wage paid, straight time or premium time.

OVERTIME PAY

See (B, E, Q) on OVERTIME PAGE. *Note* Double time for emergency work designated by the Dept. of Jurisdiction.

NOTE: WAGE CAP - Double the straight time hourly base wage shall be the maximum hourly wage compensation for any hour worked. Contractor is still responsible to pay the hourly benefit amount for each hour worked.

HOLIDAY

Paid: See (5, 6, 8, 13, 25) on HOLIDAY PAGE and Governor of NYS Election Day.

Overtime: See (5, 6, 8, 13, 25) on HOLIDAY PAGE and Governor of NYS Election Day.

NOTE: All paid holidays falling on Saturday shall be observed on the preceding Friday. All paid holidays falling on Sunday shall be observed on the following Monday. Supplements for holidays paid at straight time.

REGISTERED APPRENTICES

WAGES per hour: 1000 hour terms at the following percentage of the applicable Journeyman Lineman wage.

| | | | | | | |
|-----|-----|-----|-----|-----|-----|-----|
| 1st | 2nd | 3rd | 4th | 5th | 6th | 7th |
| 60% | 65% | 70% | 75% | 80% | 85% | 90% |

SUPPLEMENTAL BENEFITS per hour:

| | | |
|--|--|--|
| 07/01/2022 | 05/01/2023 | 05/06/2024 |
| \$ 25.90 *plus 7% of the hourly wage paid | \$ 26.40 *plus 7% of the hourly wage paid | \$ 26.90 *plus 7% of the hourly wage paid |

*The 7% is based on the hourly wage paid, straight time or premium time.

6-1249aWestLT

Mason - Building **04/01/2023**

JOB DESCRIPTION Mason - Building

DISTRICT 9

ENTIRE COUNTIES

Nassau, Rockland, Suffolk, Westchester

WAGES

| | | | |
|--------------|------------|------------|-------------------------------------|
| Per hour: | 07/01/2022 | 12/05/2022 | 06/05/2023 Additional \$ 0.73 |
| Tile Setters | \$ 62.01 | \$ 62.62 | |

SUPPLEMENTAL BENEFITS

| | | |
|-----------|-----------|-----------|
| Per Hour: | \$ 26.13* | \$ 25.26* |
| | + \$10.02 | + \$10.03 |

* This portion of benefits subject to same premium rate as shown for overtime wages.

OVERTIME PAY

See (B, E, Q, V) on OVERTIME PAGE

Work beyond 10 hours on Saturday shall be paid at double the hourly wage rate.

HOLIDAY

Paid: See (1) on HOLIDAY PAGE

Overtime: See (5, 6, 11, 15, 16, 25) on HOLIDAY PAGE

REGISTERED APPRENTICES

Wage per hour:

(750 hour) term at the following wage rate:

| | | | | | | | | | | |
|-------|-------|----------|-----------|-----------|-----------|-----------|-----------|-----------|-----------|-----------|
| Term: | 1st | 2nd | 3rd | 4th | 5th | 6th | 7th | 8th | 9th | 10th |
| | 1-750 | 751-1500 | 1501-2250 | 2251-3000 | 3001-3750 | 3751-4500 | 4501-5250 | 5251-6000 | 6001-6750 | 6501-7000 |

| | | | | | | | | | | |
|------------|---------|---------|---------|---------|---------|---------|---------|---------|---------|---------|
| 07/01/2022 | \$21.23 | \$26.11 | \$33.26 | \$38.14 | \$41.67 | \$45.04 | \$48.60 | \$53.47 | \$56.25 | \$60.33 |
| 12/05/2022 | \$21.47 | \$26.39 | \$33.60 | \$38.52 | \$42.06 | \$45.47 | \$49.05 | \$53.96 | \$56.77 | \$60.90 |

Supplemental Benefits per hour:

| | 1st | 2nd | 3rd | 4th | 5th | 6th | 7th | 8th | 9th | 10th |
|------------|----------|----------|----------|----------|----------|----------|----------|----------|----------|----------|
| 07/01/2022 | \$12.55* | \$12.55* | \$15.16* | \$15.16* | \$16.75* | \$18.30* | \$19.35* | \$19.40* | \$17.45* | \$22.80* |
| | +\$0.69 | +\$0.74 | +\$0.84 | +\$0.88 | +\$1.28 | +\$1.33 | +\$1.70 | +\$1.75 | +\$5.90 | +\$6.42 |
| 12/05/2022 | \$12.55* | \$12.55* | \$15.16* | \$15.16* | \$16.16* | \$17.66* | \$18.66* | \$18.66* | \$16.66* | \$21.91* |
| | +\$0.71 | +\$0.76 | +\$0.86 | +\$0.90 | +\$1.32 | +\$1.37 | +\$1.76 | +\$1.81 | +\$5.96 | +\$6.51 |

* This portion of benefits subject to same premium rate as shown for overtime wages.

9-7/52A

Mason - Building **04/01/2023**

JOB DESCRIPTION Mason - Building

DISTRICT 11

ENTIRE COUNTIES
 Putnam, Rockland, Westchester

PARTIAL COUNTIES
 Orange: Only the Township of Tuxedo.

WAGES

Per hour:

| | 07/01/2022 | 06/01/2023 |
|-----------------------|------------|------------|
| Bricklayer | \$ 44.79 | \$ 45.89 |
| Cement Mason | 44.79 | 45.89 |
| Plasterer/Stone Mason | 44.79 | 45.89 |
| Pointer/Caulker | 44.79 | 45.89 |

Additional \$1.00 per hour for power saw work
 Additional \$0.50 per hour for swing scaffold or staging work

SHIFT WORK: When shift work or an irregular work day is mandated or required by state, federal, county, local or other governmental agency contracts, the following premiums apply:

- Irregular work day requires 15% premium
- Second shift an additional 15% of wage plus benefits to be paid
- Third shift an additional 25% of wage plus benefits to be paid

SUPPLEMENTAL BENEFITS

Per hour:

| | | |
|------------|----------|----------|
| Journeyman | \$ 37.00 | \$ 37.95 |
|------------|----------|----------|

OVERTIME PAY

OVERTIME:

Cement Mason See (B, E, Q, W) on OVERTIME PAGE.
 All Others See (B, E, Q) on OVERTIME PAGE.

HOLIDAY

Paid: See (1) on HOLIDAY PAGE
 Overtime: See (5, 6, 16, 25) on HOLIDAY PAGE

Whenever any of the above holidays fall on Sunday, they will be observed on Monday. Whenever any of the above holidays fall on Saturday, they will be observed on Friday.

REGISTERED APPRENTICES

Wages per hour:

750 hour terms at the following percentage of Journeyman's wage

| 1st | 2nd | 3rd | 4th | 5th | 6th | 7th | 8th |
|-----|-----|-----|-----|-----|-----|-----|-----|
| 50% | 55% | 60% | 65% | 70% | 75% | 80% | 85% |

Supplemental Benefits per hour

750 hour terms at the following percentage of journeyman supplements

| | | | | | | | |
|-----|-----|-----|-----|-----|-----|-----|-----|
| 1st | 2nd | 3rd | 4th | 5th | 6th | 7th | 8th |
| 50% | 55% | 60% | 65% | 70% | 75% | 80% | 85% |

Apprentices indentured before June 1st, 2011 receive full journeyman benefits

11-5wp-b

Mason - Building

04/01/2023

JOB DESCRIPTION Mason - Building

DISTRICT 9

ENTIRE COUNTIES

Bronx, Kings, Nassau, New York, Queens, Richmond, Suffolk, Westchester

WAGES

Building

07/01/2022

Wages per hour:

Mosaic & Terrazzo Mechanic \$ 59.21

Mosaic & Terrazzo Finisher 57.60

SUPPLEMENTAL BENEFITS

Per hour:

Mosaic & Terrazzo Mechanic \$ 26.21*
 + \$11.73

Mosaic & Terrazzo Finisher \$ 26.21*
 + \$11.72

*This portion of benefits subject to same premium rate as shown for overtime wages.

OVERTIME PAY

See (A, E, Q) on OVERTIME PAGE

07/01/2022- Deduct \$7.00 from hourly wages before calculating overtime.

HOLIDAY

Paid: See (1) on HOLIDAY PAGE

Overtime: See (5, 6, 8, 11, 15, 16, 25) on HOLIDAY PAGE

Easter Sunday is an observed holiday. Holidays falling on a Saturday will be observed on that Saturday. Holidays falling on a Sunday will be celebrated on the Monday.

REGISTERED APPRENTICES

Wages Per hour:

| 1st | 2nd | 3rd | 4th | 5th | 6th |
|------------|---------------|---------------|---------------|---------------|---------------|
| 0- 1500 | 1501- 3000 | 3001- 3750 | 3751- 4500 | 4501- 5250 | 5251- 6000 |
| \$ 22.82 | \$ 29.34 | \$ 31.32 | \$ 36.55 | \$ 41.77 | \$ 46.99 |

Supplemental Benefits per hour:

| | | | | | |
|---------|---------|----------|----------|----------|----------|
| \$4.62* | \$5.94* | \$15.73* | \$18.35* | \$20.97* | \$23.59* |
| +\$6.56 | +\$8.43 | +\$11.24 | +\$13.11 | +\$14.99 | +\$16.85 |

*This portion of benefits subject to same premium rate as shown for overtime wages.

9-7/3

Mason - Building

04/01/2023

JOB DESCRIPTION Mason - Building

DISTRICT 9

ENTIRE COUNTIES

Bronx, Kings, Nassau, New York, Queens, Richmond, Suffolk, Westchester

WAGES

Per hour:

07/01/2022

Building-Marble Restoration:
 Marble, Stone & \$ 46.60

Terrazzo Polisher, etc

SUPPLEMENTAL BENEFITS

Per Hour:
 Journeyworker:

Building-Marble Restoration:
 Marble, Stone &
 Polisher \$ 29.77

OVERTIME PAY

See (B, *E, Q, V) on OVERTIME PAGE
 *ON SATURDAYS, 8TH HOUR AND SUCCESSIVE HOURS PAID AT DOUBLE HOURLY RATE.

HOLIDAY

Paid: See (1) on HOLIDAY PAGE
 Overtime: See (5, 6, 8, 11, 15, 25) on HOLIDAY PAGE
 1ST TERM APPRENTICE GETS PAID FOR ALL OBSERVED HOLIDAYS.

REGISTERED APPRENTICES

WAGES per hour:

900 hour term at the following wage:

| 1st 1- 900 | 2nd 901- 1800 | 3rd 1801- 2700 | 4th 2701 |
|------------------|---------------------|----------------------|-------------|
| \$ 32.61 | \$ 37.28 | \$ 41.94 | \$ 46.60 |

Supplemental Benefits Per Hour:

| | | | |
|-------|-------|-------|-------|
| 27.07 | 27.97 | 28.87 | 29.77 |
|-------|-------|-------|-------|

9-7/24-MP

Mason - Building

04/01/2023

JOB DESCRIPTION Mason - Building

DISTRICT 9

ENTIRE COUNTIES

Bronx, Dutchess, Kings, Nassau, New York, Orange, Putnam, Queens, Richmond, Rockland, Suffolk, Sullivan, Ulster, Westchester

WAGES

Wages: 07/01/2022

Marble Cutters & Setters \$ 62.17

SUPPLEMENTAL BENEFITS

Per Hour:

Journeyworker \$ 38.27

OVERTIME PAY

See (B, E, Q, V) on OVERTIME PAGE

HOLIDAY

Paid: See (1) on HOLIDAY PAGE
 Overtime: See (5, 6, 8, 11, 15, 16, 25) on HOLIDAY PAGE

REGISTERED APPRENTICES

Wage Per Hour:

750 hour terms at the following wage.

| 1st | 2nd | 3rd | 4th | 5th | 6th | 7th | 8th | 9th | 10th |
|-----------|--------------|---------------|---------------|---------------|---------------|---------------|---------------|---------------|---------------|
| 1- 750 | 751- 1500 | 1501- 2250 | 2251- 3000 | 3001- 3750 | 3751- 4500 | 4501- 5250 | 5251- 6000 | 6001- 6751 | 6751- 7500 |
| \$ 24.88 | \$ 27.97 | \$ 31.08 | \$ 34.17 | \$ 37.29 | \$ 40.39 | \$ 43.51 | \$ 46.61 | \$ 52.82 | \$ 59.05 |

Supplemental Benefits per hour:

| 1st | 2nd | 3rd | 4th | 5th | 6th | 7th | 8th | 9th | 10th |
|----------|----------|----------|----------|----------|----------|----------|----------|----------|-------------------|
| \$ 20.55 | \$ 22.04 | \$ 23.52 | \$ 25.01 | \$ 26.47 | \$ 27.96 | \$ 29.42 | \$ 30.91 | \$ 33.86 | \$ 36.81 9-7/4 |

Mason - Building **04/01/2023**

JOB DESCRIPTION Mason - Building **DISTRICT 9**

ENTIRE COUNTIES
 Nassau, Rockland, Suffolk, Westchester

WAGES
 Per hour: 07/01/2022 12/05/2022 06/05/2023

Tile Finisher \$ 47.60 \$ 48.04 Additional \$ 0.58

SUPPLEMENTAL BENEFITS
 Per Hour: \$ 22.16* \$ 22.31*
 + \$9.85 + \$9.85

*This portion of benefits subject to same premium rate as shown for overtime wages

OVERTIME PAY
 See (B, E, Q, *V) on OVERTIME PAGE
 *Work beyond 10 hours on a Saturday shall be paid at double the hourly wage rate.

HOLIDAY
 Paid: See (1) on HOLIDAY PAGE
 Overtime: See (5, 6, 11, 15, 16, 25) on HOLIDAY PAGE

9-7/88A-tf

Mason - Building **04/01/2023**

JOB DESCRIPTION Mason - Building **DISTRICT 9**

ENTIRE COUNTIES
 Bronx, Kings, Nassau, New York, Queens, Richmond, Suffolk, Westchester

WAGES
 Per hour: 07/01/2022

Marble, Stone, etc.
 Maintenance Finishers: \$ 27.01

Note 1: An additional \$2.00 per hour for time spent grinding floor using "60 grit" and below.
 Note 2: Flaming equipment operator shall be paid an additional \$25.00 per day.

SUPPLEMENTAL BENEFITS
 Per Hour: \$ 14.40

Marble, Stone, etc
 Maintenance Finishers: \$ 14.40

OVERTIME PAY
 See (B, *E, Q, V) on OVERTIME PAGE
 *Double hourly rate after 8 hours on Saturday

HOLIDAY
 Paid: See (5, 6, 8, 11, 15, 25) on HOLIDAY PAGE
 Overtime: See (5, 6, 8, 11, 15, 25) on HOLIDAY PAGE
 1st term apprentice gets paid for all observed holidays.

REGISTERED APPRENTICES
 WAGES per hour: 07/01/2022

0-750 \$ 21.67

| | |
|-----------|-------|
| 751-1500 | 22.38 |
| 1501-2250 | 23.10 |
| 2251-3000 | 23.80 |
| 3001-3750 | 24.87 |
| 3751-4500 | 26.29 |
| 4501+ | 27.01 |

Supplemental Benefits:
 Per hour:

| | |
|-----------|-------|
| 0-750 | 11.52 |
| 751-1500 | 11.90 |
| 1501-2250 | 12.29 |
| 2251-3000 | 12.67 |
| 3001-3750 | 13.25 |
| 3751-4500 | 14.01 |
| 4501+ | 14.40 |

9-7/24M-MF

Mason - Building / Heavy&Highway **04/01/2023**

JOB DESCRIPTION Mason - Building / Heavy&Highway

DISTRICT 9

ENTIRE COUNTIES

Bronx, Kings, Nassau, New York, Queens, Richmond, Suffolk, Westchester

WAGES

Per hour: 07/01/2022

Marble-Finisher \$ 48.97

SUPPLEMENTAL BENEFITS

Journeyworker:
 per hour

Marble- Finisher \$ 35.76

OVERTIME PAY

See (B, E, Q, V) on OVERTIME PAGE

Work beyond 8 hours on a Saturday shall be paid at double the rate.

HOLIDAY

Overtime: See (5, 6, 8, 11, 15, 16, 25) on HOLIDAY PAGE

When an observed holiday falls on a Sunday, it will be observed the next day.

9-7/20-MF

Mason - Heavy&Highway **04/01/2023**

JOB DESCRIPTION Mason - Heavy&Highway

DISTRICT 11

ENTIRE COUNTIES

Putnam, Rockland, Westchester

PARTIAL COUNTIES

Orange: Only the Township of Tuxedo.

WAGES

Per hour: 07/01/2022 06/01/2023

| | | |
|--------------------|----------|----------|
| Bricklayer | \$ 45.29 | \$ 46.39 |
| Cement Mason | 45.29 | 46.39 |
| Marble/Stone Mason | 45.29 | 46.39 |
| Plasterer | 45.29 | 46.39 |
| Pointer/Caulker | 45.29 | 46.39 |

Additional \$1.00 per hour for power saw work
 Additional \$0.50 per hour for swing scaffold or staging work

SHIFT WORK: When shift work or an irregular work day is mandated or required by state, federal, county, local or other governmental contracts, the following rates apply:

- Irregular work day requires 15% premium
- Second shift an additional 15% of wage plus benefits to be paid

Third shift an additional 25% of wage plus benefits to be paid

SUPPLEMENTAL BENEFITS

Per hour:

Journeyman \$ 37.00 \$ 37.95

OVERTIME PAY

Cement Mason See (B, E, Q, W)
 All Others See (B, E, Q,)

HOLIDAY

Paid: See (5, 6, 16, 25) on HOLIDAY PAGE
 Overtime: See (5, 6, 16, 25) on HOLIDAY PAGE

- Whenever any of the above holidays fall on Sunday, they will be observed on Monday. Whenever any of the above holidays fall on Saturday, they will be observed on Friday.
- Supplemental Benefits are not paid for paid Holiday
- If Holiday is worked, Supplemental Benefits are paid for hours worked.
- Whenever an Employee works within three (3) calendar days before a holiday, the Employee shall be paid for the Holiday.

REGISTERED APPRENTICES

Wages per hour:

750 hour terms at the following percentage of Journeyman's wage

| 1st | 2nd | 3rd | 4th | 5th | 6th | 7th | 8th |
|-----|-----|-----|-----|-----|-----|-----|-----|
| 50% | 55% | 60% | 65% | 70% | 75% | 80% | 85% |

Supplemental Benefits per hour

750 hour terms at the following percentage of journeyman supplements

| 1st | 2nd | 3rd | 4th | 5th | 6th | 7th | 8th |
|-----|-----|-----|-----|-----|-----|-----|-----|
| 50% | 55% | 60% | 65% | 70% | 75% | 80% | 85% |

Apprentices indentured before June 1st, 2011 receive full journeyman benefits

11-5WP-H/H

Operating Engineer - Building **04/01/2023**

JOB DESCRIPTION Operating Engineer - Building

DISTRICT 9

ENTIRE COUNTIES

Bronx, Kings, New York, Putnam, Queens, Richmond, Westchester

PARTIAL COUNTIES

Dutchess: that part of Dutchess County lying south of the North City Line of the City of Poughkeepsie.

WAGES

- NOTE: Construction surveying
- Party Chief--One who directs a survey party
- Instrument Man--One who runs the instrument and assists Party Chief.
- Rodman--One who holds the rod and assists the Survey Crew

Wages:(Per Hour) 07/01/2022

Building Construction:

| | |
|----------------|----------|
| Party Chief | \$ 76.64 |
| Instrument Man | 60.50 |
| Rodman | 40.64 |

Steel Erection:

| | |
|----------------|-------|
| Party Chief | 79.41 |
| Instrument Man | 62.85 |
| Rodman | 43.48 |

Heavy Construction-NYC counties only:
 (Foundation, Excavation.)

| | |
|----------------|-------|
| Party Chief | 84.60 |
| Instrument man | 63.79 |
| Rodman | 54.52 |

SUPPLEMENTAL BENEFITS

| | |
|-----------------------|--------------------|
| Per Hour: | 07/01/2022 |
| Building Construction | \$ 26.69* +\$ 7.40 |
| Steel Erection | 27.29* +\$ 7.40 |
| Heavy Construction | 25.25* +\$ 7.15 |

* This portion subject to same premium as wages

Non-Worked Holiday Supplemental Benefit:
16.45

OVERTIME PAY

See (A, B, E, Q) on OVERTIME PAGE

Code "A" applies to Building Construction and has double the rate after 7 hours on Saturdays.

Code "B" applies to Heavy Construction and Steel Erection and had double the rate after 8 hours on Saturdays.

HOLIDAY

Paid: See (5, 6, 9, 11, 15, 16, 25) on HOLIDAY PAGE

Overtime: See (5, 6, 9, 11, 15, 16, 25) on HOLIDAY PAGE

9-15Db

Operating Engineer - Building

04/01/2023

JOB DESCRIPTION Operating Engineer - Building

DISTRICT 8

ENTIRE COUNTIES

Putnam, Westchester

PARTIAL COUNTIES

Dutchess: All the counties of Westchester and Putnam and the southern part of Dutchess County defined by the northern boundary line of the City of Poughkeepsie, then due east to Route 115, then north along Route 115 to Bedell Road, then east along Bedell Road to Van Wagner Road, then north along Van Wagner Road to Bower Road, then east along Bower Road to Route 44 and along Route 44 east to Route 343, then along Route 343 east to the northern boundary of Town of Dover Plains and east along the northern boundary of Town of Dover Plains to the border line of the State of Connecticut and bordered on the west by the middle of the Hudson River.

WAGES

GROUP I:

Cranes (All Types up to 49 tons), Boom Trucks, Cherry Pickers (All Types), Clamshell Crane, Derrick (Stone and Steel), Dragline, Franki Pile Rig or similar, High Lift (Lull or similar) with crane attachment and winch used for hoisting or lifting, Hydraulic Cranes, Pile Drivers, Potain and similar.

Cranes (All types 50-99 tons), Drill Rig Casa Grande (CAT or similar), Franki Pile Rig or similar, Hydraulic Cranes (All types including Crawler Cranes- No specific boom length).

Cranes (All types 100 tons and over), All Tower Cranes, All Climbing Cranes irrespective of manufacturer and regardless of how the same is rigged, Franki Pile Rig or similar, Conventional Cranes (All types including Crawler Cranes-No specific boom length), Hydraulic Cranes.

GROUP I-A: Barber Green Loader-Euclid Loader, Bulldozer, Carrier-Trailer Horse, Concrete Cleaning Decontamination Machine Operator, Concrete-Portable Hoist, Conway or Similar Mucking Machines, Elevator & Cage, Excavators all types, Front End Loaders, Gradall, Shovel, Backhoe, etc.(Crawler or Truck), Heavy Equipment Robotics Operator/Mechanic, Hoist Engineer-Material, Hoist Portable Mobile Unit, Hoist(Single, Double or Triple Drum), Horizontal Directional Drill Locator, Horizontal Directional Drill Operator and Jersey Spreader, Letourneau or Tournapull(Scrapers over 20 yards Struck), Lift Slab Console, etc., Lull HiLift or Similar, Master Environmental Maintenance Mechanics, Mucking Machines Operator/Mechanic or Similar Type, Overhead Crane, Pavement Breaker(Air Ram), Paver(Concrete), Post Hole Digger, Power House Plant, Road Boring Machine, Road Mix Machine, Ross Carrier and Similar Machines, Rubber tire double end backhoes and similar machines, Scoopmobile Tractor-Shovel Over 1.5 yards, Shovel (Tunnels), Spreader (Asphalt) Telephie(Cableway), Tractor Type Demolition Equipment, Trenching Machines-Vermeer Concrete Saw Trencher and Similar, Ultra High Pressure Waterjet Cutting Tool System, Vacuum Blasting Machine operator/mechanic, Winch Truck A Frame.

GROUP I-B: Compressor (Steel Erection), Mechanic (Outside All Types), Negative Air Machine (Asbestos Removal), Push Button (Buzz Box) Elevator.

GROUP II: Compactor Self-Propelled, Concrete Pump, Crane Operator in Training (Over 100 Tons), Grader, Machines Pulling Sheep's Foot Roller, Roller (4 ton and over), Scrapers (20 yards Struck and Under), Vibratory Rollers, Welder.

GROUP III-A: Asphalt Plant, Concrete Mixing Plants, Forklift (All power sources), Joy Drill or similar, Tractor Drilling Machine, Loader (1 1/2 yards and under), Portable Asphalt Plant, Portable Batch Plant, Portable Crusher, Skid Steer (Bobcat or similar), Stone Crusher, Well Drilling Machine, Well Point System.

GROUP III-B: Compressor Over 125 cu. Feet, Conveyor Belt Machine regardless of size, Compressor Plant, Ladder Hoist, Stud Machine.

GROUP IV-A: Batch Plant, Concrete Breaker, Concrete Spreader, Curb Cutter Machine, Finishing Machine-Concrete, Fine Grading Machine, Hepa Vac Clean Air Machine, Material Hopper(sand, stone, cement), Mulching Grass Spreader, Pump Gypsum etc, Pump-Plaster-GROUT-Fireproofing. Roller(Under 4 Ton),Spreading and Fine Grading Machine, Steel Cutting Machine, Siphon Pump, Tar Joint Machine, Television Cameras for Water, Sewer, Gas etc. Turbo Jet Burner or Similar Equipment, Vibrator (1 to 5).

GROUP IV-B: Compressor (all types), Heater (All Types), Fire Watchman, Lighting Unit (Portable & Generator) Pump, Pump Station(Water, Sewer, Portable, Temporary), Welding Machine (Steel Erection & Excavation).

GROUP V: Mechanics Helper, Motorized Roller (walk behind), Stock Attendant, Welder's Helper, Maintenance Engineer Crane(75 ton and over).

Group VI-A: Welder Certified

GROUP VI-B: Utility Man, Warehouse Man.

WAGES: (per hour)

| | 07/01/2022 | 03/06/2023 | 03/04/2024 |
|----------------------------|------------|------------|------------|
| GROUP I | | | |
| Cranes- up to 49 tons | \$ 65.03 | \$ 66.23 | \$ 67.43 |
| Cranes- 50 tons to 99 tons | 67.28 | 68.53 | 69.77 |
| Cranes- 100 tons and over | 76.77 | 78.21 | 79.64 |
| GROUP I-A | 56.97 | 58.01 | 59.04 |
| GROUP I-B | 52.52 | 53.48 | 54.41 |
| GROUP II | 54.98 | 55.98 | 56.97 |
| GROUP III-A | 52.97 | 53.94 | 54.88 |
| GROUP III-B | 50.44 | 51.35 | 52.25 |
| GROUP IV-A | 52.44 | 53.40 | 54.33 |
| GROUP IV-B | 44.38 | 45.17 | 45.94 |
| GROUP V | 47.83 | 48.69 | 49.53 |
| Group VI-A | 55.93 | 56.96 | 57.96 |
| GROUP VI-B | | | |
| Utility Man | 45.39 | 46.21 | 47.00 |
| Warehouse Man | 47.57 | 48.52 | 49.26 |

An additional 20% to wage when required to wear protective equipment on hazardous/toxic waste projects.
 Engineers operating cranes with booms 100 feet but less than 149 feet in length will be paid an additional \$2.00 per hour.
 Engineers operating cranes with booms 149 feet or over in length will be paid an additional \$3.00 per hour.
 Loader operators over 5 cubic yard capacity additional .50 per hour.
 Shovel operators over 4 cubic yard capacity additional \$1.00 per hour.

SUPPLEMENTAL BENEFITS

Per hour:

| | | | |
|---------------|----------|----------|----------|
| Journeyworker | \$ 29.87 | \$ 30.57 | \$ 31.32 |
|---------------|----------|----------|----------|

OVERTIME PAY

See (B, E, Q, V) on OVERTIME PAGE

HOLIDAY

Paid: See (5, 6, 8, 15, 25, 26) on HOLIDAY PAGE
 Overtime: See (5, 6, 8, 15, 25, 26) on HOLIDAY PAGE

8-137B

Operating Engineer - Heavy&Highway **04/01/2023**

JOB DESCRIPTION Operating Engineer - Heavy&Highway

DISTRICT 8

ENTIRE COUNTIES

Putnam, Westchester

PARTIAL COUNTIES

Dutchess: All the counties of Westchester and Putnam and the southern part of Dutchess County defined by the northern boundary line of the City of Poughkeepsie, then due east to Route 115, then north along Route 115 to Bedell Road, then east along Bedell Road to Van Wagner Road, then north along Van Wagner Road to Bower Road, then east along Bower Road to Route 44 and along Route 44 east to Route 343, then along Route 343 east to the northern boundary of Town of Dover Plains and east along the northern boundary of Town of Dover Plains to the border line of the State of Connecticut and bordered on the west by the middle of the Hudson River.

WAGES

GROUP I: Boom Truck, Cherry Picker, Clamshell, Crane, (Crawler, Truck), Dragline, Drill Rig (Casa Grande, Cat, or Similar), Floating Crane (Crane on Barges) under 100 tons, Gin Pole, Hoist Engineer-Concrete (Crane-Derrick-Mine Hoist), Knuckle Boom Crane, Rough Terrain Crane.

GROUP I-A: Auger (Truck or Truck Mounted), Boat Captain, Bulldozer-All Sizes, Central Mix Plant Operator, Chipper (all types), Close Circuit T.V., Combination Loader/Backhoe, Compactor with Blade, Concrete Finishing Machine, Gradall, Grader (Motor Grader), Elevator & Cage (Materials or Passenger), Excavator (and all attachments), Front End Loaders (1 1/2 yards and over), High Lift Lull and similar, Hoist (Single, Double, Triple Drum), Hoist Portable Mobile Unit, Hoist Engineer (Material), Jack and Bore Machine, Log Skidders, Mill Machines, Mucking Machines, Overhead Crane, Paver (concrete), Post Pounder (of any type), Push Cats, Road Reclaimer, Robot Hammer (Brokk or similar), Robotic Equipment (Scope of Engineer Schedule), Ross Carrier and similar, Scrapers (20 yard struck and over), Side Boom, Slip Form Machine, Spreader (Asphalt), Trenching Machines (Telephies-Vermeer Concrete Saw), Tractor Type Demolition Equipment, Vacuum Truck. Vibratory Roller(Riding) or Roller used in mainline paving operations.

GROUP I-B: Asphalt Mobile Conveyor/Transfer Machine, Road Paver (Asphalt).

GROUP II-A: Ballast Regulators, Compactor Self Propelled, Fusion Machine, Rail Anchor Machines, Roller (4 ton and over), Scrapers (20 yard struck and under).

GROUP II-B: Mechanic (Outside) All Types, Shop Mechanic.

GROUP III: Air Tractor Drill, Asphalt Plant, Batch Plant, Boiler (High Pressure), Concrete Breaker (Track or Rubber Tire), Concrete Pump, Concrete Spreader, Excavator Drill, Farm Tractor, Forklift (all types), Gas Tapping (Live), Hydroseeder, Loader (1 1/2 yards and under), Locomotive (all sizes), Machine Pulling Sheeps Foot Roller, Portable Asphalt Plant, Portable Batch Plant, Portable Crusher (Apprentice), Powerhouse Plant, Roller (under 4 ton), Sheer Excavator, Skid Steer/Bobcat, Stone Crusher, Sweeper (with seat), Well Drilling Machine.

GROUP IV: Service Person (Grease Truck), Deckhand.

GROUP IV-B: Conveyor Belt Machine (Truck Mounted), Heater (all types), Lighting Unit (Portable), Maintenance Engineer (For Crane Only), Mechanics Helper, Pump (Fireproofing), Pumps-Pump Station/Water/Sewer/Gypsum/Plaster, etc., Pump Truck (Sewer Jet or Similar), Welders Helper, Welding Machine (Steel Erection), Well Point System.

GROUP V: All Tower Cranes-All Climbing Cranes and all cranes of 100-ton capacity or greater (3900 Manitowac or similar) irrespective of manufacturer and regardless of how the same is rigged, Hoist Engineer (Steel), Engineer-Pile Driver, Jersey Spreader, Pavement Breaker/Post Hole Digger.

| WAGES: Per hour: | 07/01/2022 | 03/06/2023 | 03/04/2024 |
|---|------------|------------|------------|
| Group I | \$ 65.97 | \$ 67.27 | \$ 68.63 |
| Group I-A | 58.16 | 59.26 | 60.42 |
| Group I-B | 61.28 | 62.46 | 63.70 |
| Group II-A | 55.70 | 56.74 | 57.84 |
| Group II-B | 57.44 | 58.52 | 59.67 |
| Group III | 54.72 | 55.74 | 56.81 |
| Group IV | 49.74 | 50.63 | 51.57 |
| Group IV-B | 42.71 | 43.43 | 44.19 |
| Group V | | | |
| Engineer All Tower, Climbing and Cranes of 100 Tons | 74.73 | 76.24 | 77.82 |
| Hoist Engineer(Steel) | 67.67 | 69.01 | 70.41 |
| Engineer(Pile Driver) | 72.16 | 73.61 | 75.13 |
| Jersey Spreader, Pavement Breaker (Air Ram)Post Hole Digger | 56.99 | 58.06 | 59.19 |

SHIFT DIFFERENTIAL:

A 15% premium on all hours paid, including overtime hours for 2nd, 3rd shifts on all government mandated off-shift work

Engineers operating cranes with booms 100 feet but less than 149 feet in length will be paid an additional \$2.00 per hour over the rate listed in the Wage Schedule. Engineers operating cranes with booms 149 feet or over in length will be paid an additional \$3.00 per hour over the rate listed in the Wage Schedule. Loader and Excavator Operators: over 5 cubic yards capacity \$0.50 per hour over the rate listed in the Wage Schedule. Shovel Operators: over 4 cubic yards capacity \$1.00 per hour over the rate listed in the Wage Schedule.

Four (4), ten (10) hour days may be worked at straight time during a week, Monday thru Thursday; Friday may be used as a make-up day.

NOTE - In order to use the 4 Day/10 Hour Work schedule Registration for Use of 4 Day/10 Hour Work Schedule, form PW30.1; and there must be a dispensation of hours in place on the project. If the PW30.1 is not submitted you may be liable for overtime payments for work over 8 hours per day.

SUPPLEMENTAL BENEFITS

Per hour:

| | | | |
|----------------|--|--|--|
| Journeyworker: | \$ 32.60 up to 40 Hours | \$ 33.75 up to 40 hours | \$ 34.85 up to 40 hours |
| | After 40 hours \$ 23.40* PLUS \$ 1.20 on all hours worked | After 40 hours \$ 24.50* PLUS \$ 1.25 on all hours worked | After 40 hours \$ 25.55* PLUS \$ 1.25 on all hours worked |

*This amount is subject to premium

OVERTIME PAY

See (B, E, P, *R, **U) on OVERTIME PAGE

HOLIDAY

Paid:..... See (5, 6, 8, 15, 25, 26) on HOLIDAY PAGE

Overtime..... See (5, 6, 8, 15, 25, 26) on OVERTIME PAGE

* For Holiday codes 8,15,25,26 code R applies

** For Holiday Codes 5 & 6 code U applies

Note: If employees are required to work on Easter Sunday they shall be paid at the rate of triple time.

REGISTERED APPRENTICES

(1)year terms at the following rate.

| | | | |
|---------------------------------|----------|----------|----------|
| 1st term | \$ 29.08 | \$ 29.63 | \$ 30.21 |
| 2nd term | 34.90 | 35.56 | 36.25 |
| 3rd term | 40.71 | 41.48 | 42.30 |
| 4th term | 46.53 | 47.41 | 48.34 |
| Supplemental Benefits per hour: | | | |
| | 24.55 | 25.70 | 26.85 |

8-137HH

Operating Engineer - Heavy&Highway

04/01/2023

JOB DESCRIPTION Operating Engineer - Heavy&Highway

DISTRICT 9

ENTIRE COUNTIES

Putnam, Westchester

PARTIAL COUNTIES

Dutchess: South of the North city line of Poughkeepsie

WAGES

Party Chief - One who directs a survey party

Instrument Man - One who runs the instrument and assists Party Chief

Rodman - One who holds the rod and in general, assists the Survey Crew

Categories cover GPS & Underground Surveying

Per Hour: 07/01/2022

| | |
|----------------|----------|
| Party Chief | \$ 81.72 |
| Instrument Man | 61.43 |
| Rodman | 52.40 |

SUPPLEMENTAL BENEFITS

Per Hour: 07/01/2022

All Categories
 Straight Time: \$ 25.25* plus \$7.15

Premium:
 Time & 1/2 \$ 37.88* plus \$7.15

Double Time \$ 50.50* plus \$7.15

Non-Worked Holiday Supplemental Benefits:
 \$ 16.45

OVERTIME PAY

See (B, *E, Q) on OVERTIME PAGE

* Doubletime paid on all hours in excess of 8 hours on Saturday

HOLIDAY

Paid: See (5, 6, 7, 11, 12) on HOLIDAY PAGE

Overtime: See (5, 6, 7, 11, 12) on HOLIDAY PAGE

9-15Dh

Operating Engineer - Heavy&Highway - Tunnel

04/01/2023

JOB DESCRIPTION Operating Engineer - Heavy&Highway - Tunnel

DISTRICT 8

ENTIRE COUNTIES

Putnam, Westchester

PARTIAL COUNTIES

Dutchess: All the counties of Westchester and Putnam and the southern part of Dutchess County defined by the northern boundary line of the City of Poughkeepsie, then due east to Route 115, then north along Route 115 to Bedell Road, then east along Bedell Road to Van Wagner Road, then north along Van Wagner Road to Bower Road, then east along Bower Road to Route 44 and along Route 44 east to Route 343, then along Route 343 east to the northern boundary of Town of Dover Plains and east along the northern boundary of Town of Dover Plains to the border line of the State of Connecticut and bordered on the west by the middle of the Hudson River.

WAGES

GROUP I: Boom Truck, Cherry Picker, Clamshell, Crane(Crawler, Truck), Dragline, Drill Rig Casa Grande(Cat or Similar), Floating Crane(Crane on Barge-Under 100 Tons), Hoist Engineer(Concrete/Crane-Derrick-Mine Hoist), Knuckle Boom Crane, Rough Terrain Crane.

GROUP I-A: Auger(Truck or Truck Mounted), Boat Captain, Bull Dozer-all sizes, Central Mix Plant Operator, Chipper-all types, Close Circuit T.V., Combination Loader/Backhoe, Compactor with Blade, Concrete Finishing Machine, Gradall, Grader(Motor Grader), Elevator & Cage(Materials or Passengers), Excavator(and all attachments), Front End Loaders(1 1/2 yards and over), High Lift Lull, Hoist(Single, Double, Triple Drum), Hoist Portable Mobile Unit, Hoist Engineer(Material), Jack and Bore Machine, Log Skidder, Milling Machine, Moveable Concrete Barrier Transfer & Transport Vehicle, Mucking Machines. Overhead Crane, Paver(Concrete), Post Pounder of any type, Push Cats, Road Reclaimer, Robot Hammer(Brokk or similar), Robotic Equipment(Scope of Engineer Schedule), Ross Carrier and similar machines, Scrapers(20 yards struck and over), Side Boom, Slip Form Machine, Spreader(Asphalt), Trenching Machines, Telephies-Vermeer Concrete Saw, Tractor type demolition equipment, Vacuum Truck, Vibratory Roller (Riding) used in mainline paving operations.

GROUP I-B: Asphalt Mobile Conveyor/Transfer Machine, Road Paver(Asphalt).

GROUP II-A: Ballast Regulators, Compactor(Self-propelled), Fusion Machine, Rail Anchor Machines, Roller(4 ton and over), Scrapers(20 yard struck and under).

GROUP II-B: Mechanic(outside)all types, Shop Mechanic.

GROUP III: Air Tractor Drill, Asphalt Plant, Batch Plant, Boiler(High Pressure), Concrete Breaker(Track or Rubber Tire), Concrete Pump, Concrete Spreader, Excavator Drill, Farm Tractor, Forklift(all types of power), Gas Tapping(Live), Hydroseeder, Loader(1 1/2 yards and under), Locomotive(all sizes), Machine Pulling Sheeps Foot Roller, Portable Asphalt Plant, Portable Batch Plant, Portable Crusher(Apprentice), Powerhouse Plant, Roller(under 4 ton), Sheer Excavator, Skidsteer/Bobcat, Stone Crusher, Sweeper(with seat), Well Drilling Machine.

GROUP IV-A: Service Person(Grease Truck), Deckhand.

GROUP IV-B: Conveyor Belt Machine(Truck Mounted), Heater(all types), Lighting Unit(Portable), Maintenance Engineer(for Crane only), Mechanics Helper, Pump(Fireproofing), Pumps-Pump Station/Water/Sewer/Gypsum/Plaster, etc., Pump Truck(Sewer Jet or similar), Welding Machine(Steel Erection), Welders Helper.

GROUP V-A: Engineer(all Tower Cranes, all Climbing Cranes & all Cranes of 100 ton capacity or greater),Hoist Engineer(Steel-Sub Structure), Engineer-Pile Driver, Jersey-Spreader, Pavement breaker, Post Hole Digger

WAGES: (per hour)

| | 07/01/2022 | 03/06/2023 | 03/04/2024 |
|------------|------------|------------|------------|
| GROUP I | \$ 65.97 | \$ 67.27 | \$ 68.63 |
| GROUP I-A | 58.16 | 59.26 | 60.42 |
| GROUP I-B | 61.28 | 62.46 | 63.70 |
| GROUP II-A | 55.70 | 56.74 | 57.84 |
| GROUP II-B | 57.44 | 58.52 | 59.67 |
| GROUP III | 54.72 | 55.74 | 56.81 |
| GROUP IV-A | 49.74 | 50.63 | 51.57 |

| | | | |
|----------------------|-------|-------|-------|
| GROUP IV-B | 42.71 | 43.43 | 44.19 |
| GROUP V-A | | | |
| Engineer-Cranes | 74.73 | 76.24 | 77.82 |
| Engineer-Pile Driver | 72.16 | 73.61 | 75.13 |
| Hoist Engineer | 67.67 | 69.01 | 70.41 |
| Jersey Spreader/Post | | | |
| Hole Digger | 56.99 | 58.06 | 59.19 |

SHIFT DIFFERENTIAL:

A 15% premium on all hours paid, including overtime hours for 2nd, 3rd shifts on all government mandated off-shift work

An additional 20% to wage when required to wear protective equipment on hazardous/toxic waste projects. Operators required to use two buckets pouring concrete on other than road pavement shall receive \$0.50 per hour over scale. Engineers operating cranes with booms 100 feet but less than 149 feet in length will be paid an additional \$2.00 per hour. Engineers operating cranes with booms 149 feet or over in length will be paid an additional \$3.00 per hour. Operators of shovels with a capacity over (4) cubic yards shall be paid an additional \$1.00 per hour. Operators of loaders with a capacity over (5) cubic yards shall be paid an additional \$0.50 per hour.

SUPPLEMENTAL BENEFITS

Per hour:

Journeyworker:

| | | |
|---|---|---|
| \$ 32.60 up to 40 hours | \$ 33.75 up to 40 hours | \$ 34.85 up to 40 hours |
| After 40 hours \$23.40 plus \$1.20 on all hours worked | After 40 hours \$24.50 plus \$1.25 on all hours worked | After 40 hours \$25.55 plus \$1.25 on all hours worked |

OVERTIME PAY

See (D, O, *U, V) on OVERTIME PAGE

HOLIDAY

Paid: See (5, 6, 8, 15, 25, 26) on HOLIDAY PAGE

Overtime: See (5, 6, 8, 15, 25, 26) on HOLIDAY PAGE

* Note: For Holiday codes 5 & 6, code U applies. For Holiday codes 8, 15, 25, 26, code R applies.

Note: If employees are required to work on Easter Sunday, they shall be paid at the rate of triple time.

REGISTERED APPRENTICES

(1)year terms at the following rates:

| | | | |
|----------|----------|----------|----------|
| 1st term | \$ 29.08 | \$ 29.63 | \$ 30.21 |
| 2nd term | 34.90 | 35.56 | 36.25 |
| 3rd term | 40.71 | 41.48 | 42.30 |
| 4th term | 46.53 | 47.41 | 48.34 |

Supplemental Benefits per hour:

| | | | |
|-----------|----------|----------|----------|
| All terms | \$ 24.55 | \$ 25.70 | \$ 26.85 |
|-----------|----------|----------|----------|

8-137Tun

Operating Engineer - Marine Dredging

04/01/2023

JOB DESCRIPTION Operating Engineer - Marine Dredging

DISTRICT 4

ENTIRE COUNTIES

Albany, Bronx, Cayuga, Clinton, Columbia, Dutchess, Essex, Franklin, Greene, Jefferson, Kings, Monroe, Nassau, New York, Orange, Oswego, Putnam, Queens, Rensselaer, Richmond, Rockland, St. Lawrence, Suffolk, Ulster, Washington, Wayne, Westchester

WAGES

These wages do not apply to Operating Engineers on land based construction projects. For those projects, please see the Operating Engineer Heavy/Highway Rates. The wage rates below for all equipment and operators are only for marine dredging work in navigable waters found in the counties listed above.

| | | |
|---|------------|------------|
| Per Hour: | 07/01/2022 | 10/01/2022 |
| CLASS A1 Deck Captain, Leverman Mechanical Dredge Operator Licensed Tug Operator 1000HP or more. | \$ 42.66 | \$ 43.94 |
| CLASS A2 | 38.02 | 39.16 |

Crane Operator (360 swing)

CLASS B To conform to Operating Engineer
 Dozer, Front Loader Prevailing Wage in locality where work
 Operator on Land is being performed including benefits.

| | | |
|---|-------|-------|
| CLASS B1 | 36.89 | 38.00 |
| Derrick Operator (180 swing) Spider/Spill Barge Operator Operator II, Fill Placer, Engineer, Chief Mate, Electrician, Chief Welder, Maintenance Engineer Licensed Boat, Crew Boat Operator | | |

| | | |
|------------------|-------|-------|
| CLASS B2 | 34.73 | 35.77 |
| Certified Welder | | |

| | | |
|---|-------|-------|
| CLASS C1 | 33.78 | 34.79 |
| Drag Barge Operator, Steward, Mate, Assistant Fill Placer | | |

| | | |
|---------------|-------|-------|
| CLASS C2 | 32.69 | 33.67 |
| Boat Operator | | |

| | | |
|---|-------|-------|
| CLASS D | 27.16 | 27.97 |
| Shoreman, Deckhand, Oiler, Rodman, Scowman, Cook, Messman, Porter/Janitor | | |

SUPPLEMENTAL BENEFITS

Per Hour:
 THE FOLLOWING SUPPLEMENTAL BENEFITS APPLY TO ALL CATEGORIES

| | | |
|-------------------|---|---|
| All Classes A & B | \$ 11.40 plus 6% of straight time wage, Overtime hours add \$ 0.63 | \$ 11.85 plus 6% of straight time wage, Overtime hours add \$ 0.63 |
| All Class C | \$ 11.10 plus 6% of straight time wage, Overtime hours add \$ 0.48 | \$ 11.60 plus 6% of straight time wage, Overtime hours add \$ 0.50 |
| All Class D | \$ 10.80 plus 6% of straight time wage, Overtime hours add \$ 0.33 | \$ 11.35 plus 6% of straight time wage, Overtime hours add \$ 0.38 |

OVERTIME PAY
 See (B2, F, R) on OVERTIME PAGE

HOLIDAY
 Paid: See (1) on HOLIDAY PAGE
 Overtime: See (5, 6, 8, 15, 26) on HOLIDAY PAGE

4-25a-MarDredge

Operating Engineer - Survey Crew - Consulting Engineer **04/01/2023**

JOB DESCRIPTION Operating Engineer - Survey Crew - Consulting Engineer **DISTRICT 9**

ENTIRE COUNTIES
 Bronx, Kings, Nassau, New York, Putnam, Queens, Richmond, Suffolk, Westchester

PARTIAL COUNTIES
 Dutchess: That part in Dutchess County lying South of the North City line of Poughkeepsie.

WAGES
 Feasibility and preliminary design surveying, any line and grade surveying for inspection or supervision of construction.

Per hour: 07/01/2022
Survey Classifications

Party Chief \$ 46.44
Instrument Man 38.60
Rodman 33.64

SUPPLEMENTAL BENEFITS

Per Hour:

All Crew Members: \$ 21.60

OVERTIME PAY

OVERTIME:.... See (B, E*, Q, V) ON OVERTIME PAGE.

*Doubletime paid on the 9th hour on Saturday.

HOLIDAY

Paid: See (5, 6, 7, 11, 16) on HOLIDAY PAGE

Overtime: See (5, 6, 7, 11, 16) on HOLIDAY PAGE

9-15dconsult

Painter

04/01/2023

JOB DESCRIPTION Painter

DISTRICT 8

ENTIRE COUNTIES

Bronx, Kings, Nassau, New York, Putnam, Queens, Richmond, Suffolk, Westchester

WAGES

Per hour: 07/01/2022

Brush \$ 51.45*

Abatement/Removal of lead based
or lead containing paint on
materials to be repainted. 51.45*

Spray & Scaffold \$ 54.45*

Fire Escape 54.45*

Decorator 54.45*

Paperhanger/Wall Coverer 53.83*

*Subtract \$ 0.10 to calculate premium rate.

SUPPLEMENTAL BENEFITS

Per hour:

Paperhanger \$ 33.15

All others 30.88

Premium 37.72**

**Applies only to "All others" category, not paperhanger journeyworker.

OVERTIME PAY

See (A, H) on OVERTIME PAGE

HOLIDAY

Paid: See (1) on HOLIDAY PAGE

Overtime: See (5, 6, 16, 25) on HOLIDAY PAGE

REGISTERED APPRENTICES

One (1) year terms at the following wage rate.

Per hour: 07/01/2022

Appr 1st term... \$ 19.95*

Appr 2nd term... 25.56*

Appr 3rd term... 31.00*

Appr 4th term... 41.52*

*Subtract \$ 0.10 to calculate premium rate.

Supplemental benefits:

Per Hour:

| | |
|------------------|----------|
| Appr 1st term... | \$ 15.22 |
| Appr 2nd term... | 18.90 |
| Appr 3rd term... | 21.81 |
| Appr 4th term... | 27.58 |

8-NYDC9-B/S

Painter

04/01/2023

JOB DESCRIPTION Painter

DISTRICT 8

ENTIRE COUNTIES

Putnam, Suffolk, Westchester

PARTIAL COUNTIES

Nassau: All of Nassau except the areas described below: Atlantic Beach, Ceaderhurst, East Rockaway, Gibson, Hewlett, Hewlett Bay, Hewlett Neck, Hewlett Park, Inwood, Lawrence, Lido Beach, Long Beach, parts of Lynbrook, parts of Oceanside, parts of Valley Stream, and Woodmere. Starting on the South side of Sunrise Hwy in Valley Stream running east to Windsor and Rockaway Ave., Rockville Centre is the boundary line up to Lawson Blvd. turn right going west all the above territory. Starting at Union Turnpike and Lakeville Rd. going north to Northern Blvd. the west side of Lakeville road to Northern blvd. At Northern blvd. going east the district north of Northern blvd. to Port Washington Blvd. West of Port Washington blvd. to St. Francis Hospital then north of first traffic light to Port Washington and Sands Point, Manor HAVen, Harbour Acres.

WAGES

| | |
|---------------|------------|
| Per hour: | 07/01/2022 |
| Drywall Taper | \$ 51.45* |

*Subtract \$ 0.10 to calculate premium rate.

SUPPLEMENTAL BENEFITS

| | |
|------------|----------|
| Per hour: | |
| Journeyman | \$ 30.88 |

OVERTIME PAY

See (A, H) on OVERTIME PAGE

HOLIDAY

| | |
|-----------|------------------------------------|
| Paid: | See (1) on HOLIDAY PAGE |
| Overtime: | See (5, 6, 16, 25) on HOLIDAY PAGE |

REGISTERED APPRENTICES

Wages - Per Hour:

1500 hour terms at the following wage rate:

| | |
|----------|-----------|
| 1st term | \$ 19.95* |
| 2nd term | 25.56* |
| 3rd term | 31.00* |
| 4th term | 41.52* |

*Subtract \$ 0.10 to calculate premium rate.

Supplemental Benefits - Per hour:

One year term (1500 hours) at the following dollar amount.

| | |
|----------|----------|
| 1st year | \$ 15.22 |
| 2nd year | 18.90 |
| 3rd year | 21.81 |
| 4th year | 27.58 |

8-NYDCT9-DWT

Painter - Bridge & Structural Steel

04/01/2023

JOB DESCRIPTION Painter - Bridge & Structural Steel

DISTRICT 8

ENTIRE COUNTIES

Albany, Bronx, Clinton, Columbia, Dutchess, Essex, Franklin, Fulton, Greene, Hamilton, Kings, Montgomery, Nassau, New York, Orange, Putnam, Queens, Rensselaer, Richmond, Rockland, Saratoga, Schenectady, Schoharie, Suffolk, Sullivan, Ulster, Warren, Washington, Westchester

WAGES

| | | |
|------------------|------------|------------|
| Per Hour: | | |
| STEEL: | | |
| Bridge Painting: | 07/01/2022 | 10/01/2022 |
| | \$ 53.00 | \$ 54.50 |
| | + 9.63* | + 10.10* |

ADDITIONAL \$6.00 per hour for POWER TOOL/SPRAY, whether straight time or overtime.

NOTE: All premium wages are to be calculated on base rate per hour only.

* For the period of May 1st to November 15th, this amount is payable up to 40 hours. For the period of Nov 16th to April 30th, this amount is payable up to 50 hours. EXCEPTION: First and last week of employment, and for the weeks of Memorial Day, Independence Day and Labor Day, where the amount is paid for the actual number of hours worked (no cap).

NOTE: Generally, for Bridge Painting Contracts, ALL WORKERS on and off the bridge (including Flagmen) are to be paid Painter's Rate; the contract must be ONLY for Bridge Painting.

SHIFT WORK:

When directly specified in public agency or authority contract documents for an employer to work a second shift and works the second shift with employees other than from the first shift, all employees who work the second shift will be paid 10% of the base wage shift differential in lieu of overtime for the first eight (8) hours worked after which the employees shall be paid at time and one half of the regular wage rate. When a single irregular work shift is mandated in the job specifications or by the contracting agency, wages shall be paid at time and one half for single shifts between the hours of 3pm-11pm or 11pm-7am.

SUPPLEMENTAL BENEFITS

Per Hour:

| | | |
|----------------|----------|----------|
| Journeyworker: | \$ 10.90 | \$ 11.78 |
| | + 30.60* | + 30.75* |

* For the period of May 1st to November 15th, this amount is payable up to 40 hours. For the period of Nov 16th to April 30th, this amount is payable up to 50 hours. EXCEPTION: First and last week of employment, and for the weeks of Memorial Day, Independence Day and Labor Day, where the amount is paid for the actual number of hours worked (no cap).

OVERTIME PAY

See (B, F, R) on OVERTIME PAGE

HOLIDAY

Paid: See (1) on HOLIDAY PAGE
 Overtime: See (4, 6) on HOLIDAY PAGE

REGISTERED APPRENTICES

Wage - Per hour:
 Apprentices: (1) year terms

| | | |
|-----------------------------------|----------|----------|
| 1st year | \$ 21.20 | \$ 21.80 |
| | + 3.86 | + 4.04 |
| 2nd year | \$ 31.80 | \$ 32.70 |
| | + 5.78 | + 6.06 |
| 3rd year | \$ 42.40 | \$ 43.60 |
| | + 7.70 | + 8.08 |
| Supplemental Benefits - Per hour: | | |
| 1st year | \$.25 | \$.25 |
| | + 12.24 | + 12.34 |
| 2nd year | \$ 10.90 | \$ 10.90 |
| | + 18.36 | + 18.51 |
| 3rd year | \$ 10.90 | \$ 10.90 |
| | + 24.48 | + 24.68 |

NOTE: All premium wages are to be calculated on base rate per hour only.

8-DC-9/806/155-BrSS

| | |
|--------------------------------|-------------------|
| Painter - Line Striping | 04/01/2023 |
|--------------------------------|-------------------|

JOB DESCRIPTION Painter - Line Striping
ENTIRE COUNTIES

DISTRICT 8

Albany, Clinton, Columbia, Dutchess, Essex, Franklin, Fulton, Greene, Hamilton, Montgomery, Nassau, Orange, Putnam, Rensselaer, Rockland, Saratoga, Schenectady, Schoharie, Suffolk, Sullivan, Ulster, Warren, Washington, Westchester

WAGES

Per hour:

| | |
|-----------------------------|------------|
| Painter (Striping-Highway): | 07/01/2022 |
| Striping-Machine Operator* | \$ 31.53 |
| Linerman Thermoplastic | 38.34 |

Note: * Includes but is not limited to: Positioning of cones and directing of traffic using hand held devices. Excludes the Driver/Operator of equipment used in the maintenance and protection of traffic safety.

Four (4), ten (10) hour days may be worked at straight time during a week, Monday thru Thursday. Friday may be used as a make-up day.

NOTE - In order to use the '4 Day/10 Hour Work Schedule,' as your normal schedule, you must submit an 'Employer Registration for Use of 4 Day/10 Hour Work Schedule,' form PW30.1; and there must be a dispensation of hours in place on the project. If the PW30.1 is not submitted you may be liable for overtime payments for work over 8 hours per day.

SUPPLEMENTAL BENEFITS

Per hour paid:

| | |
|----------------------------|----------|
| Journeyworker: | |
| Striping Machine Operator: | \$ 10.03 |
| Linerman Thermoplastic: | 10.03 |

OVERTIME PAY

See (B, B2, E2, F, S) on OVERTIME PAGE

HOLIDAY

Paid: See (5, 20) on HOLIDAY PAGE
 Overtime: See (5, 20) on HOLIDAY PAGE

REGISTERED APPRENTICES

One (1) year terms at the following wage rates:

| | |
|-----------|----------|
| 1st Term: | \$ 15.00 |
| 2nd Term: | 18.92 |
| 3rd Term: | 25.22 |

Supplemental Benefits per hour:

| | |
|-----------|---------|
| 1st term: | \$ 9.16 |
| 2nd Term: | 10.03 |
| 3rd Term: | 10.03 |

8-1456-LS

Painter - Metal Polisher **04/01/2023**

JOB DESCRIPTION Painter - Metal Polisher

DISTRICT 8

ENTIRE COUNTIES

Albany, Allegany, Bronx, Broome, Cattaraugus, Cayuga, Chautauqua, Chemung, Chenango, Clinton, Columbia, Cortland, Delaware, Dutchess, Erie, Essex, Franklin, Fulton, Genesee, Greene, Hamilton, Herkimer, Jefferson, Kings, Lewis, Livingston, Madison, Monroe, Montgomery, Nassau, New York, Niagara, Oneida, Onondaga, Ontario, Orange, Orleans, Oswego, Otsego, Putnam, Queens, Rensselaer, Richmond, Rockland, Saratoga, Schenectady, Schoharie, Schuylar, Seneca, St. Lawrence, Steuben, Suffolk, Sullivan, Tioga, Tompkins, Ulster, Warren, Washington, Wayne, Westchester, Wyoming, Yates

WAGES

| | |
|------------------|------------|
| | 07/01/2022 |
| Metal Polisher | \$ 37.78 |
| Metal Polisher* | 38.80 |
| Metal Polisher** | 41.78 |

*Note: Applies on New Construction & complete renovation
 ** Note: Applies when working on scaffolds over 34 feet.

SUPPLEMENTAL BENEFITS

| | |
|--------------------|------------|
| Per Hour: | 07/01/2022 |
| Journeyworker: | |
| All classification | \$ 11.24 |

OVERTIME PAY

See (B, E, P, T) on OVERTIME PAGE

HOLIDAY

Paid: See (5, 6, 11, 15, 16, 25, 26) on HOLIDAY PAGE
 Overtime: See (5, 6, 9, 11, 15, 16, 25, 26) on HOLIDAY PAGE

REGISTERED APPRENTICES

Wages per hour:
 One (1) year term at the following wage rates:

| | |
|------------|------------|
| | 07/01/2022 |
| 1st year | \$ 16.00 |
| 2nd year | 17.00 |
| 3rd year | 18.00 |
| 1st year* | \$ 16.39 |
| 2nd year* | 17.44 |
| 3rd year* | 18.54 |
| 1st year** | \$ 18.50 |
| 2nd year** | 19.50 |
| 3rd year** | 20.50 |

*Note: Applies on New Construction & complete renovation
 ** Note: Applies when working on scaffolds over 34 feet.

Supplemental benefits:
 Per hour:

| | |
|----------|---------|
| 1st year | \$ 7.99 |
| 2nd year | 7.99 |
| 3rd year | 7.99 |

8-8A/28A-MP

Plumber

04/01/2023

JOB DESCRIPTION Plumber

DISTRICT 8

ENTIRE COUNTIES
 Putnam, Westchester

WAGES
 Per hour:

| | |
|----------------------------|------------|
| | 07/01/2022 |
| Plumber and Steamfitter | \$ 60.21 |

SHIFT WORK:

When directly specified in public agency or authority contract documents, shift work outside the regular hours of work shall be comprised of eight (8) hours per shift not including Saturday, Sundays and holidays. One half (1/2) hour shall be allowed for lunch after the first four (4) hours of each shift. Wage and Fringes for shift work shall be straight time plus a shift premium of twenty-five (25%) percent. A minimum of five days Monday through Friday must be worked to establish shift work.

SUPPLEMENTAL BENEFITS

Per hour:

Journeyworker \$ 40.01

OVERTIME PAY

See (B, E, E2, Q, V) on OVERTIME PAGE
 OVERTIME:... See on OVERTIME PAGE.

HOLIDAY

Paid: See (1) on HOLIDAY PAGE
 Overtime: See (5, 6, 8, 16, 25) on HOLIDAY PAGE

REGISTERED APPRENTICES

(1)year terms at the following wages:

| | |
|----------|----------|
| 1st Term | \$ 22.36 |
| 2nd Term | 25.66 |
| 3rd Term | 29.63 |
| 4th Term | 42.28 |

5th Term 45.36

Supplemental Benefits per hour:

| | |
|----------|----------|
| 1st term | \$ 16.54 |
| 2nd term | 18.46 |
| 3rd term | 21.96 |
| 4th term | 28.95 |
| 5th term | 30.68 |

8-21.1-ST

Plumber - HVAC / Service

04/01/2023

JOB DESCRIPTION Plumber - HVAC / Service

DISTRICT 8

ENTIRE COUNTIES

Dutchess, Putnam, Westchester

PARTIAL COUNTIES

Delaware: Only the townships of Middletown and Roxbury

Ulster: Entire County(including Wallkill and Shawangunk Prisons) except for remainder of Town of Shawangunk and Towns of Plattekill, Marlboro, and Wawarsing.

WAGES

Per hour: 07/01/2022

| | |
|--------------|------------|
| HVAC Service | \$ 41.68 |
| | + \$ 4.32* |

*Note: This portion of wage is not subject to overtime premium.

SUPPLEMENTAL BENEFITS

Per hour:

| | |
|----------------------------|----------|
| Journeyworker HVAC Service | \$ 27.79 |
|----------------------------|----------|

OVERTIME PAY

See (B, F, R) on OVERTIME PAGE

HOLIDAY

Paid: See (5, 6, 16, 25) on HOLIDAY PAGE

Overtime: See (5, 6, 16, 25) on HOLIDAY PAGE

REGISTERED APPRENTICES

HVAC SERVICE

(1)year terms at the following wages:

| | | | | |
|----------|----------|----------|----------|----------|
| 1st yr. | 2nd yr. | 3rd yr. | 4th yr. | 5th yr. |
| \$ 18.87 | \$ 22.36 | \$ 27.91 | \$ 34.33 | \$ 37.25 |
| +\$2.37* | +\$2.67* | +\$3.22* | +\$3.84* | +\$4.07* |

*Note: This portion of wage is not subject to overtime premium.

Supplemental Benefits per hour:

Apprentices 07/01/2022

| | |
|----------|----------|
| 1st term | \$ 20.30 |
| 2nd term | 21.62 |
| 3rd term | 23.07 |
| 4th term | 25.05 |
| 5th term | 26.47 |

8-21.1&2-SF/Re/AC

Plumber - Jobbing & Alterations

04/01/2023

JOB DESCRIPTION Plumber - Jobbing & Alterations

DISTRICT 8

ENTIRE COUNTIES

Dutchess, Putnam, Westchester

PARTIAL COUNTIES

Ulster: Entire county (including Walkill and Shawangunk Prisons in Town of Shawangunk) EXCEPT for remainder of Town of Shawangunk, and Towns of Plattekill, Marlboro, and Wawarsing.

WAGES

Per hour: 07/01/2022
 Journeyworker: \$ 46.79

Repairs, replacements and alteration work is any repair or replacement of a present plumbing system that does not change existing roughing or water supply lines.

SHIFT WORK:

When directly specified in public agency or authority contract documents, shift work outside the regular hours of work shall be comprised of eight (8) hours per shift not including Saturday, Sundays and holidays. One half (1/2) hour shall be allowed for lunch after the first four (4) hours of each shift. Wage and Fringes for shift work shall be straight time plus a shift premium of twenty-five (25%) percent. A minimum of five days Monday through Friday must be worked to establish shift work.

SUPPLEMENTAL BENEFITS

Per hour:
 Journeyworker \$ 33.56

OVERTIME PAY

See (B, *E, E2, Q, V) on OVERTIME PAGE

*When used as a make-up day, hours after 8 on Saturday shall be paid at time and one half.

HOLIDAY

Paid: See (1) on HOLIDAY PAGE
 Overtime: See (5, 6, 8, 16, 25) on HOLIDAY PAGE

REGISTERED APPRENTICES

(1) year terms at the following wages:

| | |
|----------|----------|
| 1st year | \$ 20.25 |
| 2nd year | 22.48 |
| 3rd year | 24.40 |
| 4th year | 34.25 |
| 5th year | 36.19 |

Supplemental Benefits per hour:

| | |
|----------|----------|
| 1st year | \$ 10.98 |
| 2nd year | 12.92 |
| 3rd year | 16.89 |
| 4th year | 22.82 |
| 5th year | 24.77 |

8-21.3-J&A

Roofer **04/01/2023**

JOB DESCRIPTION Roofer

DISTRICT 9

ENTIRE COUNTIES

Bronx, Dutchess, Kings, New York, Orange, Putnam, Queens, Richmond, Rockland, Sullivan, Ulster, Westchester

WAGES

| | | |
|---------------------|------------|--------------------|
| Per Hour: | 07/01/2022 | 05/01/2023 |
| Roofer/Waterproofer | \$ 45.25 | Additional \$ 2.00 |
| | + \$7.00* | |

* This portion is not subjected to overtime premiums.

Note: Abatement/Removal of Asbestos containing roofs and roofing material is classified as Roofer.

SUPPLEMENTAL BENEFITS

Per Hour: \$ 30.62

OVERTIME PAY

See (B, H) on OVERTIME PAGE

Note: An observed holiday that falls on a Sunday will be observed the following Monday.

HOLIDAY

Paid: See (1) on HOLIDAY PAGE

Overtime: See (5, 6) on HOLIDAY PAGE

REGISTERED APPRENTICES

(1) year term

| | | | | |
|--|----------|----------|----------|----------|
| | 1st | 2nd | 3rd | 4th |
| | \$ 15.84 | \$ 22.63 | \$ 27.15 | \$ 33.94 |
| | | + 3.50* | + 4.20* | + 5.26* |

Supplements:

| | | | | |
|--|---------|----------|----------|----------|
| | 1st | 2nd | 3rd | 4th |
| | \$ 3.88 | \$ 15.48 | \$ 18.50 | \$ 23.04 |

* This portion is not subjected to overtime premiums.

9-8R

Sheetmetal Worker

04/01/2023

JOB DESCRIPTION Sheetmetal Worker

DISTRICT 8

ENTIRE COUNTIES

Dutchess, Orange, Putnam, Rockland, Sullivan, Ulster, Westchester

WAGES

| | |
|-------------------|------------|
| | 07/01/2022 |
| SheetMetal Worker | \$ 45.25 |
| | + 3.52* |

*This portion is not subject to overtime premiums.

SHIFT WORK

For all NYS D.O.T. and other Governmental mandated off-shift work:
 10% increase for additional shifts for a minimum of five (5) days

SUPPLEMENTAL BENEFITS

Journeyworker \$ 45.20

OVERTIME PAY

OVERTIME:.. See (B, E, Q,) on OVERTIME PAGE.

HOLIDAY

Paid: See (1) on HOLIDAY PAGE

Overtime: See (5, 6, 8, 15, 16, 23) on HOLIDAY PAGE

REGISTERED APPRENTICES

| | | | | | | | | |
|--|----------|----------|----------|----------|----------|----------|----------|----------|
| | 1st | 2nd | 3rd | 4th | 5th | 6th | 7th | 8th |
| | \$ 16.79 | \$ 18.88 | \$ 21.00 | \$ 23.08 | \$ 25.20 | \$ 27.30 | \$ 29.89 | \$ 32.43 |
| | + 1.41* | + 1.58* | + 1.76* | + 1.94* | + 2.11* | + 2.29* | + 2.46* | + 2.64* |

*This portion is not subject to overtime premiums.

Supplemental Benefits per hour:

Apprentices

| | |
|----------|----------|
| 1st term | \$ 19.37 |
| 2nd term | 21.81 |
| 3rd term | 24.21 |
| 4th term | 26.65 |
| 5th term | 29.06 |
| 6th term | 31.48 |
| 7th term | 33.42 |
| 8th term | 35.40 |

8-38

Sheetmetal Worker

04/01/2023

JOB DESCRIPTION Sheetmetal Worker

DISTRICT 4

ENTIRE COUNTIES

Bronx, Kings, Nassau, New York, Queens, Richmond, Rockland, Suffolk, Westchester

WAGES

Per Hour: 07/01/2022

Sign Erector \$ 53.79

NOTE: Structurally Supported Overhead Highway Signs(See STRUCTURAL IRON WORKER CLASS)

SUPPLEMENTAL BENEFITS

Per Hour: 07/01/2022

Sign Erector \$ 53.33

OVERTIME PAY

See (A, F, S) on OVERTIME PAGE

HOLIDAY

Paid: See (5, 6, 10, 11, 12, 16, 25) on HOLIDAY PAGE

Overtime: See (5, 6, 10, 11, 12, 16, 25) on HOLIDAY PAGE

REGISTERED APPRENTICES

Per Hour:

6 month Terms at the following percentage of Sign Erectors wage rate:

| | | | | | | | | | |
|-----|-----|-----|-----|-----|-----|-----|-----|-----|------|
| 1st | 2nd | 3rd | 4th | 5th | 6th | 7th | 8th | 9th | 10th |
| 35% | 40% | 45% | 50% | 55% | 60% | 65% | 70% | 75% | 80% |

SUPPLEMENTAL BENEFITS

Per Hour:

07/01/2022

| | | | | | | | | | |
|----------|----------|----------|----------|----------|----------|----------|----------|----------|----------|
| 1st | 2nd | 3rd | 4th | 5th | 6th | 7th | 8th | 9th | 10th |
| \$ 14.34 | \$ 16.26 | \$ 18.17 | \$ 20.10 | \$ 28.02 | \$ 30.47 | \$ 33.72 | \$ 36.27 | \$ 38.77 | \$ 41.29 |

4-137-SE

Sprinkler Fitter

04/01/2023

JOB DESCRIPTION Sprinkler Fitter

DISTRICT 1

ENTIRE COUNTIES

Dutchess, Orange, Putnam, Rockland, Sullivan, Ulster, Westchester

WAGES

Per hour 07/01/2022

Sprinkler Fitter \$ 48.98

SUPPLEMENTAL BENEFITS

Per hour

Journey person \$ 29.13

OVERTIME PAY

See (B, E, Q) on OVERTIME PAGE

HOLIDAY

Paid: See (1) on HOLIDAY PAGE

Overtime: See (5, 6) on HOLIDAY PAGE

Note: When a holiday falls on Sunday, the following Monday shall be considered a holiday and all work performed on either day shall be at the double time rate. When a holiday falls on Saturday, the preceding Friday shall be considered a holiday and all work performed on either day shall be at the double time rate.

REGISTERED APPRENTICES

Wages per hour

One Half Year terms at the following wage.

| | | | | | | | | | |
|----------|----------|----------|----------|----------|----------|----------|----------|----------|----------|
| 1st | 2nd | 3rd | 4th | 5th | 6th | 7th | 8th | 9th | 10th |
| \$ 23.70 | \$ 26.34 | \$ 28.72 | \$ 31.35 | \$ 33.99 | \$ 36.62 | \$ 39.25 | \$ 41.89 | \$ 44.52 | \$ 47.15 |

Supplemental Benefits per hour

| | | | | | | | | | |
|---------|---------|----------|----------|----------|----------|----------|----------|----------|----------|
| 1st | 2nd | 3rd | 4th | 5th | 6th | 7th | 8th | 9th | 10th |
| \$ 8.37 | \$ 8.37 | \$ 19.76 | \$ 19.76 | \$ 20.01 | \$ 20.01 | \$ 20.01 | \$ 20.01 | \$ 20.01 | \$ 20.01 |

1-669.2

Teamster - Building / Heavy&Highway

04/01/2023

JOB DESCRIPTION Teamster - Building / Heavy&Highway

DISTRICT 8

ENTIRE COUNTIES

Putnam, Westchester

WAGES

GROUP A: Straight Trucks (6-wheeler and 10-wheeler), A-frame, Winch, Dynamite Seeding, Mulching, Agitator, Water, Attenuator, Light Towers, Cement (all types), Suburban, Station Wagons, Cars, Pick Ups, any vehicle carrying materials of any kind.

GROUP AA: Tack Coat

GROUP B: Tractor & Trailers (all types).

GROUP BB: Tri-Axle, 14 Wheeler

GROUP C: Low Boy (carrying equipment).

GROUP D: Fuel Trucks, Tire Trucks.

GROUP E: Off-road Equipment (over 40 tons): Athey Wagons, Belly Dumps, Articulated Dumps, Trailer Wagons.

GROUP F: Off-road Equipment (over 40 tons) Euclid, DJB.

GROUP G: Off-road Equipment (under 40 tons) Athey Wagons, Belly Articulated Dumps, Trailer Wagons.

GROUP H: Off-road Equipment (under 40 tons), Euclid.

GROUP HH: Off-road Equipment (under 40 tons) D.J.B.

GROUP I: Off-road Equipment (under 40 tons) Darts.

GROUP II: Off-road Equipment (under 40 tons) RXS.

WAGES:(per hour)

07/01/2022

| | |
|----------|-----------|
| GROUP A | \$ 46.07* |
| GROUP AA | 49.07* |
| GROUP B | 46.69* |
| GROUP BB | 46.19* |
| GROUP C | 48.82* |
| GROUP D | 46.52* |
| GROUP E | 47.07* |
| GROUP F | 48.07* |
| GROUP G | 46.82* |
| GROUP H | 47.44* |
| GROUP HH | 47.82* |
| GROUP I | 47.57* |
| GROUP II | 47.94* |

* To calculate premium wage, subtract \$.20 from the hourly wage.

Note: Fuel truck operators on construction sites addit. \$5.00 per day.
For work on hazardous/toxic waste site addit. 20% of hourly rate.

Shift Differential: When mandated by the contracting agency, DOT, or any governmental agency contracts shall receive a shift differential of fifteen (15%) above the wage rate.

Four (4), ten (10) hour days may be worked at straight time during a week, Monday thru Thursday.

NOTE - In order to use the '4 Day/10 Hour Work schedule', as your normal schedule, you must submit an 'Employer Registration for Use of 4 Day/10 Hour Work Schedule,' form PW30.1; and there must be a dispensation of hours in place on the project. If the PW30.1 is not submitted you may be liable for overtime payments for work over 8 hours per day.

SUPPLEMENTAL BENEFITS

Per hour:

Journeyworker

| | |
|-----------------|----------|
| First 40 hours | \$ 33.87 |
| 41st-45th hours | 14.88 |
| Over 45 hours | 0.75 |

OVERTIME PAY

See (B, E, P, R) on OVERTIME PAGE

HOLIDAY

Paid: See (5, 6, 8, 9, 15, 25) on HOLIDAY PAGE

Overtime: See (5, 6, 8, 9, 15, 25) on HOLIDAY PAGE

ENTIRE COUNTIES

Albany, Allegany, Bronx, Broome, Cattaraugus, Cayuga, Chautauqua, Chemung, Chenango, Clinton, Columbia, Cortland, Delaware, Dutchess, Erie, Essex, Franklin, Fulton, Genesee, Greene, Hamilton, Herkimer, Jefferson, Kings, Lewis, Livingston, Madison, Monroe, Montgomery, Nassau, New York, Niagara, Oneida, Onondaga, Ontario, Orange, Orleans, Oswego, Otsego, Putnam, Queens, Rensselaer, Richmond, Rockland, Saratoga, Schenectady, Schoharie, Schuyler, Seneca, St. Lawrence, Steuben, Suffolk, Sullivan, Tioga, Tompkins, Ulster, Warren, Washington, Wayne, Westchester, Wyoming, Yates

WAGES

Per hour 07/01/2022

Welder: To be paid the same rate of the mechanic performing the work.*

*EXCEPTION: If a specific welder certification is required, then the 'Certified Welder' rate in that trade tag will be paid.

OVERTIME PAY

HOLIDAY

1-As Per Trade

Overtime Codes

Following is an explanation of the code(s) listed in the OVERTIME section of each classification contained in the attached schedule. Additional requirements may also be listed in the HOLIDAY section.

NOTE: Supplemental Benefits are 'Per hour worked' (for each hour worked) unless otherwise noted

- (AA) Time and one half of the hourly rate after 7 and one half hours per day
- (A) Time and one half of the hourly rate after 7 hours per day
- (B) Time and one half of the hourly rate after 8 hours per day
- (B1) Time and one half of the hourly rate for the 9th & 10th hours week days and the 1st 8 hours on Saturday.
Double the hourly rate for all additional hours
- (B2) Time and one half of the hourly rate after 40 hours per week
- (C) Double the hourly rate after 7 hours per day
- (C1) Double the hourly rate after 7 and one half hours per day
- (D) Double the hourly rate after 8 hours per day
- (D1) Double the hourly rate after 9 hours per day
- (E) Time and one half of the hourly rate on Saturday
- (E1) Time and one half 1st 4 hours on Saturday; Double the hourly rate all additional Saturday hours
- (E2) Saturday may be used as a make-up day at straight time when a day is lost during that week due to inclement weather
- (E3) Between November 1st and March 3rd Saturday may be used as a make-up day at straight time when a day is lost during that week due to inclement weather, provided a given employee has worked between 16 and 32 hours that week
- (E4) Saturday and Sunday may be used as a make-up day at straight time when a day is lost during that week due to inclement weather
- (E5) Double time after 8 hours on Saturdays
- (F) Time and one half of the hourly rate on Saturday and Sunday
- (G) Time and one half of the hourly rate on Saturday and Holidays
- (H) Time and one half of the hourly rate on Saturday, Sunday, and Holidays
- (I) Time and one half of the hourly rate on Sunday
- (J) Time and one half of the hourly rate on Sunday and Holidays
- (K) Time and one half of the hourly rate on Holidays
- (L) Double the hourly rate on Saturday
- (M) Double the hourly rate on Saturday and Sunday
- (N) Double the hourly rate on Saturday and Holidays
- (O) Double the hourly rate on Saturday, Sunday, and Holidays
- (P) Double the hourly rate on Sunday
- (Q) Double the hourly rate on Sunday and Holidays
- (R) Double the hourly rate on Holidays
- (S) Two and one half times the hourly rate for Holidays

- (S1) Two and one half times the hourly rate the first 8 hours on Sunday or Holidays One and one half times the hourly rate all additional hours.
- (T) Triple the hourly rate for Holidays
- (U) Four times the hourly rate for Holidays
- (V) Including benefits at SAME PREMIUM as shown for overtime
- (W) Time and one half for benefits on all overtime hours.
- (X) Benefits payable on Paid Holiday at straight time. If worked, additional benefit amount will be required for worked hours. (Refer to other codes listed.)

Holiday Codes

PAID Holidays:

Paid Holidays are days for which an eligible employee receives a regular day's pay, but is not required to perform work. If an employee works on a day listed as a paid holiday, this remuneration is in addition to payment of the required prevailing rate for the work actually performed.

OVERTIME Holiday Pay:

Overtime holiday pay is the premium pay that is required for work performed on specified holidays. It is only required where the employee actually performs work on such holidays. The applicable holidays are listed under HOLIDAYS: OVERTIME. The required rate of pay for these covered holidays can be found in the OVERTIME PAY section listings for each classification.

Following is an explanation of the code(s) listed in the HOLIDAY section of each classification contained in the attached schedule. The Holidays as listed below are to be paid at the wage rates at which the employee is normally classified.

- (1) None
- (2) Labor Day
- (3) Memorial Day and Labor Day
- (4) Memorial Day and July 4th
- (5) Memorial Day, July 4th, and Labor Day
- (6) New Year's, Thanksgiving, and Christmas
- (7) Lincoln's Birthday, Washington's Birthday, and Veterans Day
- (8) Good Friday
- (9) Lincoln's Birthday
- (10) Washington's Birthday
- (11) Columbus Day
- (12) Election Day
- (13) Presidential Election Day
- (14) 1/2 Day on Presidential Election Day
- (15) Veterans Day
- (16) Day after Thanksgiving
- (17) July 4th
- (18) 1/2 Day before Christmas
- (19) 1/2 Day before New Years
- (20) Thanksgiving
- (21) New Year's Day
- (22) Christmas
- (23) Day before Christmas
- (24) Day before New Year's
- (25) Presidents' Day
- (26) Martin Luther King, Jr. Day
- (27) Memorial Day
- (28) Easter Sunday

(29) Juneteenth



**New York State Department of Labor - Bureau of Public Work
State Office Building Campus
Building 12 - Room 130
Albany, New York 12240**

REQUEST FOR WAGE AND SUPPLEMENT INFORMATION

As Required by Articles 8 and 9 of the NYS Labor Law

Fax (518) 485-1870 or mail this form for new schedules or for determination for additional occupations.

This Form Must Be Typed

Submitted By:

(Check Only One)

Contracting Agency

Architect or Engineering Firm

Public Work District Office

Date:

A. Public Work Contract to be let by: (Enter Data Pertaining to Contracting/Public Agency)

1. Name and complete address (Check if new or change)

Telephone: ()

Fax: ()

E-Mail:

2. NY State Units (see Item 5)

01 DOT

02 OGS

03 Dormitory Authority

04 State University
Construction Fund

05 Mental Hygiene
Facilities Corp.

06 OTHER N.Y. STATE UNIT

07 City

08 Local School District

09 Special Local District, i.e.,
Fire, Sewer, Water District

10 Village

11 Town

12 County

13 Other Non-N.Y. State
(Describe)

3. SEND REPLY TO check if new or change)
Name and complete address:

Telephone:()

Fax: ()

E-Mail:

4. SERVICE REQUIRED. Check appropriate box and provide project information.

New Schedule of Wages and Supplements.

APPROXIMATE BID DATE :

Additional Occupation and/or Redetermination

PRC NUMBER ISSUED PREVIOUSLY FOR
THIS PROJECT :

OFFICE USE ONLY

B. PROJECT PARTICULARS

5. Project Title _____

Description of Work _____

Contract Identification Number _____

Note: For NYS units, the OSC Contract No. _____

6. Location of Project:
Location on Site _____

Route No/Street Address _____

Village or City _____

Town _____

County _____

7. Nature of Project - Check One:

- 1. New Building
- 2. Addition to Existing Structure
- 3. Heavy and Highway Construction (New and Repair)
- 4. New Sewer or Waterline
- 5. Other New Construction (Explain)
- 6. Other Reconstruction, Maintenance, Repair or Alteration
- 7. Demolition
- 8. Building Service Contract

8. OCCUPATION FOR PROJECT :

- Construction (Building, Heavy Highway/Sewer/Water)
- Tunnel
- Residential
- Landscape Maintenance
- Elevator maintenance
- Exterminators, Fumigators
- Fire Safety Director, NYC Only
- Guards, Watchmen
- Janitors, Porters, Cleaners, Elevator Operators
- Moving furniture and equipment
- Trash and refuse removal
- Window cleaners
- Other (Describe)

9. Has this project been reviewed for compliance with the Wicks Law involving separate bidding? YES NO

10. Name and Title of Requester

Signature



NEW YORK STATE DEPARTMENT OF LABOR
Bureau of Public Work - Debarment List

**LIST OF EMPLOYERS INELIGIBLE TO BID ON OR BE
AWARDED ANY PUBLIC WORK CONTRACT**

Under Article 8 and Article 9 of the NYS Labor Law, a contractor, sub-contractor and/or its successor shall be debarred and ineligible to submit a bid on or be awarded any public work or public building service contract/sub-contract with the state, any municipal corporation or public body for a period of five (5) years from the date of debarment when:

- Two (2) final determinations have been rendered within any consecutive six-year (6) period determining that such contractor, sub-contractor and/or its successor has WILLFULLY failed to pay the prevailing wage and/or supplements;
- One (1) final determination involves falsification of payroll records or the kickback of wages and/or supplements.

The agency issuing the determination and providing the information, is denoted under the heading 'Fiscal Officer'. DOL = New York State Department of Labor; NYC = New York City Comptroller's Office; AG = New York State Attorney General's Office; DA = County District Attorney's Office.

Debarment Database: To search for contractors, sub-contractors and/or their successors debarred from bidding or being awarded any public work contract or subcontract under NYS Labor Law Articles 8 and 9, or under NYS Workers' Compensation Law Section 141-b, access the database at this link: <https://applications.labor.ny.gov/EDList/searchPage.do>

For inquiries where WCB is listed as the "Agency", please call 1-866-546-9322

NYSDOL Bureau of Public Work Debarment List 04/03/2023

Article 8

| AGENCY | Fiscal Officer | FEIN | EMPLOYER NAME | EMPLOYER DBA NAME | ADDRESS | DEBARMENT START DATE | DEBARMENT END DATE |
|--------|----------------|-----------|--|-------------------|--|----------------------|--------------------|
| DOL | DOL | *****5754 | 0369 CONTRACTORS, LLC | | 515 WEST AVE UNIT PH 13NORWALK CT 06850 | 05/12/2021 | 05/12/2026 |
| DOL | DOL | *****4018 | ADIRONDACK BUILDING RESTORATION INC. | | 4156 WILSON ROAD EAST TABERG NY 13471 | 03/26/2019 | 03/26/2024 |
| DOL | AG | *****1812 | ADVANCED BUILDERS & LAND DEVELOPMENT, INC. | | 400 OSER AVE #2300HAUPPAUGE NY 11788 | 09/11/2019 | 09/11/2024 |
| DOL | DOL | *****1687 | ADVANCED SAFETY SPRINKLER INC | | 261 MILL ROAD P.O BOX 296EAST AURORA NY 14052 | 05/29/2019 | 05/29/2024 |
| DOL | NYC | | AGOSTINHO TOME | | 405 BARRETTO ST BRONX NY 10474 | 05/31/2018 | 05/31/2023 |
| DOL | NYC | | ALL COUNTY SEWER & DRAIN, INC. | | 7 GREENFIELD DR WARWICK NY 10990 | 03/25/2022 | 03/25/2027 |
| DOL | NYC | | AMJED PARVEZ | | 401 HANOVER AVENUE STATEN ISLAND NY 10304 | 01/11/2021 | 01/11/2026 |
| DOL | DOL | | ANGELO F COKER | | 2610 SOUTH SALINA STREET SUITE 14SYRACUSE NY 13205 | 09/17/2020 | 09/17/2025 |
| DOL | DOL | | ANGELO F COKER | | 2610 SOUTH SALINA STREET SUITE 14SYRACUSE NY 13205 | 12/04/2018 | 12/04/2023 |
| DOL | DOL | | ANGELO GARCIA | | 515 WEST AVE UNIT PH 13NORWALK CT 06850 | 05/12/2021 | 05/12/2026 |
| DOL | DOL | | ANGELO TONDO | | 449 WEST MOMBSHA ROAD MONROE NY 10950 | 06/06/2022 | 06/06/2027 |
| DOL | DOL | | ANITA SALERNO | | 158 SOLAR ST SYRACUSE NY 13204 | 01/07/2019 | 01/07/2024 |
| DOL | DOL | *****4231 | ANKER'S ELECTRIC SERVICE, INC. | | 10 SOUTH 5TH ST LOCUST VALLEY NY 11560 | 09/26/2022 | 09/26/2027 |
| DOL | DOL | | ANTONIO ESTIVEZ | | 442 ARMONK RD MOUNT KISCO NY 10549 | 06/12/2018 | 06/12/2023 |
| DOL | NYC | | ARADCO CONSTRUCTION CORP | | 115-46 132RD ST SOUTH OZONE PARK NY 11420 | 09/17/2020 | 09/17/2025 |
| DOL | DOL | | ARNOLD A. PAOLINI | | 1250 BROADWAY ST BUFFALO NY 14212 | 02/03/2020 | 02/03/2025 |
| DOL | NYC | | ARSHAD MEHMOOD | | 168-42 88TH AVENUE JAMAICA NY 11432 | 11/20/2019 | 11/20/2024 |
| DOL | NYC | *****2591 | AVI 212 INC. | | 260 CROPSEY AVENUE APT 11GBROOKLYN NY 11214 | 10/30/2018 | 10/30/2023 |
| DOL | NYC | | AVM CONSTRUCTION CORP | | 117-72 123RD ST SOUTH OZONE PARK NY 11420 | 09/17/2020 | 09/17/2025 |
| DOL | NYC | | AZIDABEGUM | | 524 MCDONALD AVENUE BROOKLYN NY 11218 | 09/17/2020 | 09/17/2025 |
| DOL | DOL | *****8421 | B & B DRYWALL, INC | | 206 WARREN AVE APT 1WHITE PLAINS NY 10603 | 12/14/2021 | 12/14/2026 |
| DOL | NYC | | BALWINDER SINGH | | 421 HUDSON ST SUITE C5NEW YORK NY 10014 | 02/20/2019 | 02/20/2024 |
| DOL | NYC | *****8416 | BEAM CONSTRUCTION, INC. | | 50 MAIN ST WHITE PLAINS NY 10606 | 01/04/2019 | 01/04/2024 |
| DOL | DOL | | BERNARD BEGLEY | | 38 LONG RIDGE ROAD BEDFORD NY 10506 | 12/18/2019 | 12/18/2024 |
| DOL | NYC | *****2113 | BHW CONTRACTING, INC. | | 401 HANOVER AVENUE STATEN ISLAND NY 10304 | 01/11/2021 | 01/11/2026 |
| DOL | DOL | | BIAGIO CANTISANI | | | 06/12/2018 | 06/12/2023 |
| DOL | DOL | *****3627 | BJB CONSTRUCTION CORP. | | 38 LONG RIDGE ROAD BEDFORD NY 10506 | 12/18/2019 | 12/18/2024 |
| DOL | DOL | *****4512 | BOB BRUNO EXCAVATING, INC | | 5 MORNINGSIDE DR AUBURN NY 13021 | 05/28/2019 | 05/28/2024 |
| DOL | DOL | | BOGDAN MARKOVSKI | | 370 W. PLEASANTVIEW AVE SUITE 2.329HACKENSACK NJ 07601 | 02/11/2019 | 02/11/2024 |
| DOL | DOL | | BRADLEY J SCHUKA | | 4 BROTHERS ROAD WAPPINGERS FALLS NY 12590 | 10/20/2020 | 10/20/2025 |
| DOL | DOL | | BRUCE P. NASH JR. | | 5841 BUTTERNUT ROAD EAST SYRACUSE NY 13057 | 09/12/2018 | 09/12/2023 |
| DOL | DOL | *****9383 | C.C. PAVING AND EXCAVATING, INC. | | 2610 SOUTH SALINA ST SUITE 12SYRACUSE NY 13205 | 09/17/2020 | 09/17/2025 |
| DOL | DOL | *****9383 | C.C. PAVING AND EXCAVATING, INC. | | 2610 SOUTH SALINA ST SUITE 12SYRACUSE NY 13205 | 12/04/2018 | 12/04/2023 |
| DOL | DOL | *****4083 | C.P.D. ENTERPRISES, INC | | P. O BOX 281 WALDEN NY 12586 | 03/03/2020 | 03/03/2025 |

NYSDOL Bureau of Public Work Debarment List 04/03/2023

Article 8

| | | | | | | | |
|-----|-----|-----------|---|---|---|------------|------------|
| DOL | DOL | *****5161 | CALADRI DEVELOPMENT CORP. | | 1223 PARK ST. PEEKSKILL NY 10566 | 05/17/2021 | 05/17/2026 |
| DOL | DOL | *****3391 | CALI ENTERPRISES, INC. | | 1223 PARK STREET PEEKSKILL NY 10566 | 05/17/2021 | 05/17/2026 |
| DOL | NYC | | CALVIN WALTERS | | 465 EAST THIRD ST MT. VERNON NY 10550 | 09/09/2019 | 09/09/2024 |
| DOL | DOL | | CANTISANI & ASSOCIATES LTD | | 442 ARMONK RD MOUNT KISCO NY 10549 | 06/12/2018 | 06/12/2023 |
| DOL | DOL | | CANTISANI HOLDING LLC | | | 06/12/2018 | 06/12/2023 |
| DOL | DOL | | CARMEN RACHETTA | | 8531 OSWEGO RD BALDWINVILLE NY 13027 | 02/03/2020 | 02/03/2025 |
| DOL | DOL | *****3812 | CARMODY "2" INC | | | 06/12/2018 | 06/12/2023 |
| DOL | DOL | *****1143 | CARMODY BUILDING CORP | CARMODY CONTRACTING AND CARMODY CONTRACTING CORP. | 442 ARMONK RD MOUNT KISCO NY 10549 | 06/12/2018 | 06/12/2023 |
| DOL | DOL | | CARMODY CONCRETE CORPORATION | | | 06/12/2018 | 06/12/2023 |
| DOL | DOL | | CARMODY ENTERPRISES, LTD. | | 442 ARMONK RD MOUNT KISCO NY 10549 | 06/12/2018 | 06/12/2023 |
| DOL | DOL | | CARMODY INC | | 442 ARMONK RD MOUNT KISCO NY 10549 | 06/12/2018 | 06/12/2023 |
| DOL | DOL | *****3812 | CARMODY INDUSTRIES INC | | | 06/12/2018 | 06/12/2023 |
| DOL | DOL | | CARMODY MAINTENANCE CORPORATION | | 442 ARMONK RD MOUNT KISCO NY 10549 | 06/12/2018 | 06/12/2023 |
| DOL | DOL | | CARMODY MASONRY CORP | | 442 ARMONK RD MOUNT KISCO NY 10549 | 06/12/2018 | 06/12/2023 |
| DOL | AG | *****7247 | CENTURY CONCRETE CORP | | 2375 RAYNOR ST RONKONKOMA NY 11779 | 08/04/2021 | 08/04/2026 |
| DOL | DOL | *****0026 | CHANTICLEER CONSTRUCTION LLC | | 4 BROTHERS ROAD WAPPINGERS FALLS NY 12590 | 10/20/2020 | 10/20/2025 |
| DOL | NYC | | CHARLES ZAHRADKA | | 863 WASHINGTON STREET FRANKLIN SQUARE NY 11010 | 03/10/2020 | 03/10/2025 |
| DOL | DOL | | CHRISTOPHER GRECO | | 26 NORTH MYRTLE AVENUE SPRING VALLEY NY 10956 | 02/18/2021 | 02/18/2026 |
| DOL | DOL | | CHRISTOPHER J MAINI | | 19 CAITLIN AVE JAMESTOWN NY 14701 | 09/17/2018 | 09/17/2023 |
| DOL | DOL | | CHRISTOPHER PAPASTEFANO A/K/A CHRIS PAPASTEFANO | | 1445 COMMERCE AVE BRONX NY 10461 | 05/30/2019 | 05/30/2024 |
| DOL | DOL | *****1927 | CONSTRUCTION PARTS WAREHOUSE, INC. | CPW | 5841 BUTTERNUT ROAD EAST SYRACUSE NY 13057 | 09/12/2018 | 09/12/2023 |
| DOL | DOL | | CRAIG JOHANSEN | | 10 SOUTH 5TH ST LOCUST VALLEY NY 11560 | 09/26/2022 | 09/26/2027 |
| DOL | DOL | *****3228 | CROSS-COUNTY LANDSCAPING AND TREE SERVICE, INC. | ROCKLAND TREE SERVICE | 26 NORTH MYRTLE AVENUE SPRING VALLEY NY 10956 | 02/18/2021 | 02/18/2026 |
| DOL | DOL | *****2524 | CSI ELECTRICAL & MECHANICAL INC | | 42-32 235TH ST DOUGLASTON NY 11363 | 01/14/2019 | 01/14/2024 |
| DOL | DOL | *****7619 | DANCO CONSTRUCTION UNLIMITED INC. | | 485 RAFT AVENUE HOLBROOK NY 11741 | 10/19/2021 | 10/19/2026 |
| DOL | DOL | | DANIEL ROBERT MCNALLY | | 7 GREENFIELD DRIVE WARWICK NY 10990 | 03/25/2022 | 03/25/2027 |
| DOL | DOL | | DARIAN L COKER | | 2610 SOUTH SALINA ST SUITE 2CSYRACUSE NY 13205 | 09/17/2020 | 09/17/2025 |
| DOL | DOL | | DARIAN L COKER | | 2610 SOUTH SALINA ST SUITE 2CSYRACUSE NY 13205 | 12/04/2018 | 12/04/2023 |
| DOL | NYC | | DAVID WEINER | | 14 NEW DROP LANE 2ND FLOORSTATEN ISLAND NY 10306 | 11/14/2019 | 11/14/2024 |
| DOL | DOL | | DELPHI PAINTING & DECORATING CO INC | | 1445 COMMERCE AVE BRONX NY 10461 | 05/30/2019 | 05/30/2024 |
| DOL | DOL | *****5175 | EAGLE MECHANICAL AND GENERAL CONSTRUCTION LLC | | 11371 RIDGE RD WOLCOTT NY 14590 | 02/03/2020 | 02/03/2025 |
| DOL | AG | | EDWIN HUTZLER | | 23 NORTH HOWELLS RD BELLPORT NY 11713 | 08/04/2021 | 08/04/2026 |
| DOL | DA | | EDWIN HUTZLER | | 2375 RAYNOR STREET RONKONKOMA NY 11779 | 08/04/2021 | 08/04/2026 |
| DOL | DOL | *****0780 | EMES HEATING & PLUMBING CONTR | | 5 EMES LANE MONSEY NY 10952 | 01/20/2002 | 01/20/3002 |

NYS DOL Bureau of Public Work Debarment List 04/03/2023

Article 8

| | | | | | | | |
|-----|-----|-----------|--|-----------------------------|---|------------|------------|
| DOL | NYC | *****5917 | EPOCH ELECTRICAL, INC | | 97-18 50TH AVE CORONA NY 11368 | 04/19/2018 | 04/19/2024 |
| DOL | DOL | | FAIGY LOWINGER | | 11 MOUNTAIN RD 28 VAN BUREN DRMONROE NY 10950 | 03/20/2019 | 03/20/2024 |
| DOL | DOL | | FRANK BENEDETTO | | 19 CATLIN AVE JAMESTOWN NY 14701 | 09/17/2018 | 09/17/2023 |
| DOL | DOL | *****4722 | FRANK BENEDETTO AND CHRISTOPHER J MAINI | B & M CONCRETE | 19 CAITLIN AVE JAMESTOWN NY 14701 | 09/17/2018 | 09/17/2023 |
| DOL | DA | | FREDERICK HUTZLER | | 2375 RAYNOR STREET RONKONKOMA NY 11779 | 08/04/2021 | 08/04/2026 |
| DOL | NYC | *****6616 | G & G MECHANICAL ENTERPRISES, LLC. | | 1936 HEMPSTEAD TURNPIKE EAST MEDOW NY 11554 | 11/29/2019 | 11/29/2024 |
| DOL | DOL | | GABRIEL FRASSETTI | | | 04/10/2019 | 04/10/2024 |
| DOL | NYC | | GAYATRI MANGRU | | 21 DAREWOOD LANE VALLEY STREAM NY 11581 | 09/17/2020 | 09/17/2025 |
| DOL | DOL | | GEOFF CORLETT | | 415 FLAGGER AVE #302STUART FL 34994 | 10/31/2018 | 10/31/2023 |
| DOL | DA | | GEORGE LUCEY | | 150 KINGS STREET BROOKLYN NY 11231 | 01/19/1998 | 01/19/2998 |
| DOL | DOL | | GIGI SCHNECKENBURGER | | 261 MILL RD EAST AURORA NY 14052 | 05/29/2019 | 05/29/2024 |
| DOL | NYC | *****3164 | GLOBE GATES INC | GLOBAL OVERHEAD DOORS | 405 BARRETTO ST BRONX NY 10474 | 05/31/2018 | 05/31/2023 |
| DOL | DOL | | HANS RATH | | 24 ELDOR AVENUE NEW CITY NY 10956 | 02/03/2020 | 02/03/2025 |
| DOL | DOL | | HERBERT CLEMEN | | 42 FOWLER AVENUE CORTLAND MANOR NY 10567 | 01/24/2023 | 01/24/2028 |
| DOL | DOL | | HERBERT CLEMEN | | 42 FOWLER AVENUE CORTLAND MANOR NY 10567 | 10/25/2022 | 10/25/2027 |
| DOL | DOL | *****5131 | INTEGRITY MASONRY, INC. | M&R CONCRETE | 722 8TH AVE WATERVLIET NY 12189 | 06/05/2018 | 06/05/2023 |
| DOL | DOL | | IRENE KASSELIS | | 32 PENNINGTON AVE WALDWICK NJ 07463 | 05/30/2019 | 05/30/2024 |
| DOL | DOL | *****9211 | J. WASE CONSTRUCTION CORP. | | 8545 RT 9W ATHENS NY 12015 | 03/09/2021 | 03/09/2026 |
| DOL | DOL | | J.M.J CONSTRUCTION | | 151 OSTRANDER AVENUE SYRACUSE NY 13205 | 11/21/2022 | 11/21/2027 |
| DOL | DOL | | J.R. NELSON CONSTRUCTION | | 531 THIRD STREET ALBANY NY 12206 | 12/22/2022 | 12/22/2027 |
| DOL | DOL | | J.R. NELSON CONSTRUCTION | | 531 THIRD STREET ALBANY NY 12206 | 10/25/2022 | 10/25/2027 |
| DOL | DOL | | J.R. NELSON, LLC | | 531 THIRD STREET ALBANY NY 12206 | 12/22/2022 | 12/22/2027 |
| DOL | DOL | | J.R. NELSON, LLC | | 531 THIRD STREET ALBANY NY 12206 | 10/25/2022 | 10/25/2027 |
| DOL | DOL | | J.R.N COMPANIES, LLC | | 531 THIRD STREET ALBANY NY 12206 | 12/12/2022 | 12/12/2027 |
| DOL | DOL | | J.R.N COMPANIES, LLC | | 531 THIRD STREET ALBANY NY 12206 | 10/25/2022 | 10/25/2027 |
| DOL | DOL | *****1147 | J.R.N. CONSTRUCTION, LLC | | 531 THIRD ST ALBANY NY 12206 | 12/22/2022 | 12/22/2027 |
| DOL | DOL | *****1147 | J.R.N. CONSTRUCTION, LLC | | 531 THIRD ST ALBANY NY 12206 | 10/25/2022 | 10/25/2027 |
| DOL | DOL | | JAMES C. DELGIACCO | | 722 8TH AVE WATERVLIET NY 12189 | 06/05/2018 | 06/05/2023 |
| DOL | DOL | | JAMES J. BAKER | | 7901 GEE ROAD CANASTOTA NY 13032 | 08/17/2021 | 08/17/2026 |
| DOL | DOL | | JAMES LIACONE | | 9365 WASHINGTON ST LOCKPORT IL 60441 | 07/23/2018 | 07/23/2023 |
| DOL | DOL | | JAMES RACHEL | | 9365 WASHINGTON ST LOCKPORT IL 60441 | 07/23/2018 | 07/23/2023 |
| DOL | DOL | | JASON P. RACE | | 3469 STATE RT. 69 PERISH NY 13131 | 09/29/2021 | 09/29/2026 |
| DOL | DOL | | JASON P. RACE | | 3469 STATE RT. 69 PERISH NY 13131 | 02/09/2022 | 02/09/2027 |
| DOL | DOL | | JASON P. RACE | | 3469 STATE RT. 69 PERISH NY 13131 | 11/15/2022 | 11/15/2027 |
| DOL | DOL | | JASON P. RACE | | 3469 STATE RT. 69 PERISH NY 13131 | 03/01/2022 | 03/01/2027 |
| DOL | DOL | *****7993 | JBS DIRT, INC. | | 7901 GEE ROAD CANASTOTA NY 13032 | 08/17/2021 | 08/17/2026 |

NYSDOL Bureau of Public Work Debarment List 04/03/2023

Article 8

| | | | | | | | |
|-----|-----|-----------|---|--------------|---|------------|------------|
| DOL | DOL | *****5368 | JCH MASONRY & LANDSCAPING INC. | | 35 CLINTON AVE OSSINING NY 10562 | 09/12/2018 | 09/12/2023 |
| DOL | DOL | *****2435 | JEFFEL D. JOHNSON | JMJ7 AND SON | 5553 CAIRNSTRAIL CLAY NY 13041 | 11/21/2022 | 11/21/2027 |
| DOL | DOL | | JEFFEL JOHNSON ELITE CARPENTER REMODEL AND CONSTRUCTION | | C2 EVERGREEN CIRCLE LIVERPOOL NY 13090 | 11/21/2022 | 11/21/2027 |
| DOL | DOL | *****2435 | JEFFREY M. JOHNSON | JMJ7 AND SON | 5553 CAIRNS TRAIL CLAY NY 13041 | 11/21/2022 | 11/21/2027 |
| DOL | NYC | | JENNIFER GUERRERO | | 1936 HEMPSTEAD TURNPIKE EAST MEADOW NY 11554 | 11/29/2019 | 11/29/2024 |
| DOL | DOL | | JIM PLAUGHER | | 17613 SANTE FE LINE ROAD WAYNEFIELD OH 45896 | 07/16/2021 | 07/16/2026 |
| DOL | DOL | | JMJ7 & SON CONSTRUCTION, LLC | | 5553 CAIRNS TRAIL LIVERPOOL NY 13041 | 11/21/2022 | 11/21/2027 |
| DOL | DOL | | JMJ7 AND SONS CONTRACTORS | | 5553 CAIRNS TRAIL CLAY NY 13041 | 11/21/2022 | 11/21/2027 |
| DOL | DOL | | JMJ7 CONTRACTORS | | 7014 13TH AVENUE BROOKLYN NY 11228 | 11/21/2022 | 11/21/2027 |
| DOL | DOL | | JMJ7 CONTRACTORS AND SONS | | 5553 CAIRNS TRAIL CLAY NY 13041 | 11/21/2022 | 11/21/2027 |
| DOL | DOL | | JMJ7 CONTRACTORS, LLC | | 5553 CAIRNS TRAIL CLAY NY 13041 | 11/21/2022 | 11/21/2027 |
| DOL | DOL | | JOHN GOCEK | | 14B COMMERCIAL AVE ALBANY NY 12065 | 11/14/2019 | 11/14/2024 |
| DOL | DOL | | JOHN LUCIANO | | | 05/14/2018 | 05/14/2023 |
| DOL | DOL | | JOHN MARKOVIC | | 47 MANDON TERRACE HAWTHORN NJ 07506 | 03/29/2021 | 03/29/2026 |
| DOL | DOL | | JOHN WASE | | 8545 RT 9W ATHENS NY 12015 | 03/09/2021 | 03/09/2026 |
| DOL | DOL | | JON E DEYOUNG | | 261 MILL RD P.O BOX 296EAST AURORA NY 14052 | 05/29/2019 | 05/29/2024 |
| DOL | DOL | | JORGE RAMOS | | 8970 MIKE GARCIA DR MANASSAS VA 20109 | 07/16/2021 | 07/16/2026 |
| DOL | DOL | | JORI PEDERSEN | | 415 FLAGER AVE #302STUART FL 34994 | 10/31/2018 | 10/31/2023 |
| DOL | DOL | | JOSE CHUCHUCA | | 35 CLINTON AVE OSSINING NY 10562 | 09/12/2018 | 09/12/2023 |
| DOL | DOL | | JOY MARTIN | | 2404 DELAWARE AVE NIGARA FALLS NY 14305 | 09/12/2018 | 09/12/2023 |
| DOL | DOL | *****5116 | JP RACE PAINTING, INC. T/A RACE PAINTING | | 3469 STATE RT. 69 PERISH NY 13131 | 02/09/2022 | 02/09/2027 |
| DOL | DOL | *****5116 | JP RACE PAINTING, INC. T/A RACE PAINTING | | 3469 STATE RT. 69 PERISH NY 13131 | 11/15/2022 | 11/15/2027 |
| DOL | DOL | *****5116 | JP RACE PAINTING, INC. T/A RACE PAINTING | | 3469 STATE RT. 69 PERISH NY 13131 | 09/29/2021 | 09/29/2026 |
| DOL | DOL | *****5116 | JP RACE PAINTING, INC. T/A RACE PAINTING | | 3469 STATE RT. 69 PERISH NY 13131 | 03/01/2022 | 03/01/2027 |
| DOL | DOL | *****5116 | JP RACE PAINTING, INC. T/A RACE PAINTING | | 3469 STATE RT. 69 PERISH NY 13131 | 03/01/2022 | 03/01/2027 |
| DOL | DOL | *****1147 | JRN CONSTRUCTION, LLC | | 531 THIRD STREET ALBANY NY 12206 | 10/25/2022 | 10/25/2027 |
| DOL | DOL | *****1147 | JRN CONSTRUCTION, LLC | | 531 THIRD STREET ALBANY NY 12206 | 12/22/2022 | 12/22/2027 |
| DOL | DOL | | JRN PAVING, LLC | | 531 THIRD STREET ALBANY NY 12206 | 10/25/2022 | 10/25/2027 |
| DOL | DOL | | JRN PAVING, LLC | | 531 THIRD STREET ALBANY NY 12206 | 12/22/2022 | 12/22/2027 |
| DOL | DOL | | JULIUS AND GITA BEHREND | | 5 EMES LANE MONSEY NY 10952 | 11/20/2002 | 11/20/3002 |
| DOL | DOL | | KARIN MANGIN | | 796 PHELPS ROAD FRANKLIN LAKES NJ 07417 | 12/01/2020 | 12/01/2025 |
| DOL | DOL | | KATE E. CONNOR | | 7088 INTERSTATE ISLAND RD SYRACUSE NY 13209 | 03/31/2021 | 03/31/2026 |
| DOL | DOL | *****2959 | KELC DEVELOPMENT, INC | | 7088 INTERSTATE ISLAND RD SYRACUSE NY 13209 | 03/31/2021 | 03/31/2026 |
| DOL | DOL | | KIMBERLY F. BAKER | | 7901 GEE ROAD CANASTOTA NY 13032 | 08/17/2021 | 08/17/2026 |
| DOL | DOL | *****3490 | L & M CONSTRUCTION/DRYWALL INC. | | 1079 YONKERS AVE YONKERS NY 10704 | 08/07/2018 | 08/07/2023 |

NYSDOL Bureau of Public Work Debarment List 04/03/2023

Article 8

| | | | | | | | |
|-----|-----|-----------|---|-----------------------------|---|------------|------------|
| DOL | DA | *****8816 | LAKE CONSTRUCTION AND DEVELOPMENT CORPORATION | | 150 KINGS STREET BROOKLYN NY 11231 | 08/19/1998 | 08/19/2998 |
| DOL | DOL | | LEROY E. NELSON JR | | 531 THIRD ST ALBANY NY 12206 | 10/25/2022 | 10/25/2027 |
| DOL | DOL | | LEROY E. NELSON JR | | 531 THIRD ST ALBANY NY 12206 | 12/22/2022 | 12/22/2027 |
| DOL | AG | *****3291 | LINTECH ELECTRIC, INC. | | 3006 TILDEN AVE BROOKLYN NY 11226 | 02/16/2022 | 02/16/2027 |
| DOL | DA | *****4460 | LONG ISLAND GLASS & STOREFRONTS, LLC | | 4 MANHASSET TRL RIDGE NY 11961 | 09/06/2018 | 09/06/2023 |
| DOL | DOL | | LOUIS A. CALICCHIA | | 1223 PARK ST. PEEKSKILL NY 10566 | 05/17/2021 | 05/17/2026 |
| DOL | NYC | | LUBOMIR PETER SVOBODA | | 27 HOUSMAN AVE STATEN ISLAND NY 10303 | 12/26/2019 | 12/26/2024 |
| DOL | NYC | | M & L STEEL & ORNAMENTAL IRON CORP. | | 27 HOUSMAN AVE STATEN ISLAND NY 10303 | 12/26/2019 | 12/26/2024 |
| DOL | DOL | *****2196 | MAINSTREAM SPECIALTIES, INC. | | 11 OLD TOWN RD SELKIRK NY 12158 | 02/02/2021 | 02/02/2026 |
| DOL | DA | | MANUEL P TOBIO | | 150 KINGS STREET BROOKLYN NY 14444 | 08/19/1998 | 08/19/2998 |
| DOL | DA | | MANUEL TOBIO | | 150 KINGS STREET BROOKLYN NY 11231 | 08/19/1998 | 08/19/2998 |
| DOL | NYC | | MAREK FABIJANOWSKI | | 50 MAIN ST WHITE PLAINS NY 10606 | 01/04/2019 | 01/04/2024 |
| DOL | NYC | | MARIA NUBILE | | 84-22 GRAND AVENUE ELMHURST NY 11373 | 03/10/2020 | 03/10/2025 |
| DOL | DOL | | MASONRY CONSTRUCTION, INC. | | 442 ARMONK RD MOUNT KISCO NY 10549 | 06/12/2018 | 06/12/2023 |
| DOL | DOL | *****3333 | MASONRY INDUSTRIES, INC. | | 442 ARMONK RD MOUNT KISCO NY 10549 | 06/12/2018 | 06/12/2023 |
| DOL | NYC | | MATINA KARAGIANNIS | | 97-18 50TH AVE CORONA NY 11368 | 04/19/2018 | 04/19/2023 |
| DOL | DOL | | MATTHEW P. KILGORE | | 4156 WILSON ROAD EAST TABERG NY 13471 | 03/26/2019 | 03/26/2024 |
| DOL | DOL | | MAURICE GAWENO | | 442 ARMONK RD MOUNT KISCO NY 10549 | 06/12/2018 | 06/12/2023 |
| DOL | DOL | | MICHAEL LENIHAN | | 1079 YONKERS AVE UNIT 4YONKERS NY 10704 | 08/07/2018 | 08/07/2023 |
| DOL | DOL | *****4829 | MILESTONE ENVIRONMENTAL CORPORATION | | 704 GINESI DRIVE SUITE 29MORGANVILLE NJ 07751 | 04/10/2019 | 04/10/2024 |
| DOL | NYC | *****9926 | MILLENNIUM FIRE PROTECTION, LLC | | 325 W. 38TH STREET SUITE 204NEW YORK NY 10018 | 11/14/2019 | 11/14/2024 |
| DOL | NYC | *****0627 | MILLENNIUM FIRE SERVICES, LLC | | 14 NEW DROP LNE 2ND FLOORSTATEN ISLAND NY 10306 | 11/14/2019 | 11/14/2024 |
| DOL | DOL | *****1320 | MJC MASON CONTRACTING, INC. | | 42 FOWLER AVENUE CORTLAND MANOR NY 10567 | 10/25/2022 | 10/25/2027 |
| DOL | DOL | *****1320 | MJC MASON CONTRACTING, INC. | | 42 FOWLER AVENUE CORTLAND MANOR NY 10567 | 01/24/2023 | 01/24/2028 |
| DOL | NYC | | MUHAMMED A. HASHEM | | 524 MCDONALD AVENUE BROOKLYN NY 11218 | 09/17/2020 | 09/17/2025 |
| DOL | NYC | | NAMOW, INC. | | 84-22 GRAND AVENUE ELMHURST NY 11373 | 03/10/2020 | 03/10/2025 |
| DOL | DA | *****9786 | NATIONAL INSULATION & GC CORP | | 180 MILLER PLACE HICKSVILLE NY 11801 | 12/12/2018 | 12/12/2023 |
| DOL | DOL | *****3684 | NATIONAL LAWN SPRINKLERS, INC. | | 645 N BROADWAY WHITE PLAINS NY 10603 | 05/14/2018 | 05/14/2023 |
| DOL | NYC | | NAVIT SINGH | | 402 JERICHO TURNPIKE NEW HYDE PARK NY 11040 | 08/10/2022 | 08/10/2027 |
| DOL | DOL | | NICHOLE E. FRASER A/K/A NICHOLE RACE | | 3469 STATE RT. 69 PERISH NY 13131 | 03/01/2022 | 03/01/2027 |
| DOL | DOL | | NICHOLE E. FRASER A/K/A NICHOLE RACE | | 3469 STATE RT. 69 PERISH NY 13131 | 11/15/2022 | 11/15/2027 |
| DOL | DOL | | NICHOLE E. FRASER A/K/A NICHOLE RACE | | 3469 STATE RT. 69 PERISH NY 13131 | 09/29/2021 | 09/29/2026 |
| DOL | DOL | | NICHOLE E. FRASER A/K/A NICHOLE RACE | | 3469 STATE RT. 69 PERISH NY 13131 | 02/09/2022 | 02/09/2027 |
| DOL | DOL | *****7429 | NICOLAE I. BARBIR | BESTUCCO CONSTRUCTION, INC. | 444 SCHANTZ ROAD ALLENTOWN PA 18104 | 09/17/2020 | 09/17/2025 |
| DOL | NYC | *****5643 | NYC LINE CONTRACTORS, INC. | | 402 JERICHO TURNPIKE NEW HYDE PARK NY 11040 | 08/10/2022 | 08/10/2027 |

NYSDOL Bureau of Public Work Debarment List 04/03/2023

Article 8

| | | | | | | | |
|-----|-----|----------|--|-------------------------------|--|------------|------------|
| DOL | DOL | | PAULINE CHAHALES | | 935 S LAKE BLVD MAHOPAC NY 10541 | 03/02/2021 | 03/02/2026 |
| DOL | DOL | | PETER STEVENS | | 11 OLD TOWN ROAD SELKIRK NY 12158 | 02/02/2021 | 02/02/2026 |
| DOL | DOL | | PETER STEVENS | | 8269 21ST ST BELLEROSE NY 11426 | 12/22/2022 | 12/22/2027 |
| DOL | DOL | ****0466 | PRECISION BUILT FENCES, INC. | | 1617 MAIN ST PEEKSKILL NY 10566 | 03/03/2020 | 03/03/2025 |
| DOL | NYC | | RASHEL CONSTRUCTION CORP | | 524 MCDONALD AVENUE BROOKLYN NY 11218 | 09/17/2020 | 09/17/2025 |
| DOL | DOL | ****1068 | RATH MECHANICAL CONTRACTORS, INC. | | 24 ELDOR AVENUE NEW CITY NY 10956 | 02/03/2020 | 02/03/2025 |
| DOL | DOL | ****2633 | RAW POWER ELECTRIC CORP. | | 3 PARK CIRCLE MIDDLETOWN NY 10940 | 07/11/2022 | 07/11/2027 |
| DOL | DA | ****7559 | REGAL CONTRACTING INC. | | 24 WOODBINE AVE NORTHPORT NY 11768 | 10/01/2020 | 10/01/2025 |
| DOL | DOL | ****9148 | RICH T CONSTRUCTION | | 107 WILLOW WOOD LANE CAMILLUS NY 13031 | 11/13/2018 | 11/13/2023 |
| DOL | DOL | | RICHARD MACONE | | 8617 THIRD AVE BROOKLYN NY 11209 | 09/17/2018 | 09/17/2023 |
| DOL | DOL | | RICHARD REGGIO | | 1617 MAIN ST PEEKSKILL NY 10566 | 03/03/2020 | 03/03/2025 |
| DOL | DOL | ****9148 | RICHARD TIMIAN | RICH T CONSTRUCTI ON | 108 LAMONT AVE SYRACUSE NY 13209 | 10/16/2018 | 10/16/2023 |
| DOL | DOL | | RICHARD TIMIAN JR. | | 108 LAMONT AVE SYRACUSE NY 13209 | 10/16/2018 | 10/16/2023 |
| DOL | DOL | | RICHARD TIMIAN JR. | | 108 LAMONT AVE SYRACUSE NY 13209 | 11/13/2018 | 11/13/2023 |
| DOL | DOL | | ROBBYE BISSESAR | | 89-51 SPRINGFIELD BLVD QUEENS VILLAGE NY 11427 | 01/11/2003 | 01/11/3003 |
| DOL | DOL | | ROBERT A. VALERINO | | 3841 LANYARD COURT NEW PORT RICHEY FL 34652 | 07/09/2019 | 07/09/2024 |
| DOL | DOL | | ROBERT BRUNO | | 5 MORNINGSIDE DRIVE AUBURN NY 13021 | 05/28/2019 | 05/28/2024 |
| DOL | DOL | | RODERICK PUGH | | 404 OAK ST SUITE 101SYRACUSE NY 13203 | 07/23/2018 | 07/23/2023 |
| DOL | DOL | ****4880 | RODERICK PUGH CONSTRUCTION INC. | | 404 OAK ST SUITE 101SYRACUSE NY 13203 | 07/23/2018 | 07/23/2023 |
| DOL | DOL | | ROMEO WARREN | | 161 ROBYN RD MONROE NY 10950 | 07/11/2022 | 07/11/2027 |
| DOL | DOL | | RONALD MESSEN | | 14B COMMERCIAL AVE ALBANY NY 12065 | 11/14/2019 | 11/14/2024 |
| DOL | DOL | | ROSEANNE CANTISANI | | | 06/12/2018 | 06/12/2023 |
| DOL | DOL | ****7172 | RZ & AL INC. | | 198 RIDGE AVENUE VALLEY STREAM NY 11581 | 06/06/2022 | 06/06/2027 |
| DOL | DOL | ****1365 | S & L PAINTING, INC. | | 11 MOUNTAIN ROAD P.O BOX 408MONROE NY 10950 | 03/20/2019 | 03/20/2024 |
| DOL | DOL | ****7730 | S C MARTIN GROUP INC. | | 2404 DELAWARE AVE NIAGARA FALLS NY 14305 | 09/12/2018 | 09/12/2023 |
| DOL | DOL | | SAL FRESINA MASONRY CONTRACTORS, INC. | | 1935 TEALL AVENUE SYRACUSE NY 13206 | 07/16/2021 | 07/16/2026 |
| DOL | DOL | | SAL MASONRY CONTRACTORS, INC. | | (SEE COMMENTS) SYRACUSE NY 13202 | 07/16/2021 | 07/16/2026 |
| DOL | DOL | ****9874 | SALFREE ENTERPRISES INC | | P.O BOX 14 2821 GARDNER RD POMPEI NY 13138 | 07/16/2021 | 07/16/2026 |
| DOL | DOL | | SALVATORE A FRESINA A/K/A SAM FRESINA | | 107 FACTORY AVE P.O BOX 11070SYRACUSE NY 13218 | 07/16/2021 | 07/16/2026 |
| DOL | DOL | | SAM FRESINA | | 107 FACTORY AVE P.O BOX 11070SYRACUSE NY 13218 | 07/16/2021 | 07/16/2026 |
| DOL | NYC | ****0349 | SAM WATERPROOFING INC | | 168-42 88TH AVENUE APT.1 AJAMAICA NY 11432 | 11/20/2019 | 11/20/2024 |
| DOL | NYC | ****1130 | SCANA CONSTRUCTION CORP. | | 863 WASHINGTON STREET FRANKLIN SQUARE NY 11010 | 03/10/2020 | 03/10/2025 |
| DOL | DOL | ****2045 | SCOTT DUFFIE | DUFFIE'S ELECTRIC, INC. | P.O BOX 111 CORNWALL NY 12518 | 03/03/2020 | 03/03/2025 |
| DOL | DOL | | SCOTT DUFFIE | | P.O BOX 111 CORNWALL NY 12518 | 03/03/2020 | 03/03/2025 |

NYSDOL Bureau of Public Work Debarment List 04/03/2023

Article 8

| | | | | | | | |
|-----|-----|-----------|--|-------------------|--|------------|------------|
| DOL | NYC | *****6597 | SHAIRA CONSTRUCTION CORP. | | 421 HUDSON STREET SUITE C5NEW YORK NY 10014 | 02/20/2019 | 02/20/2024 |
| DOL | DOL | | SHANE NOLAN | | 9365 WASHINGTON ST LOCKPORT IL 60441 | 07/23/2018 | 07/23/2023 |
| DOL | DOL | | SHULEM LOWINGER | | 11 MOUNTAIN ROAD 28 VAN BUREN DRMONROE NY 10950 | 03/20/2019 | 03/20/2024 |
| DOL | DOL | *****0816 | SOLAR ARRAY SOLUTIONS, LLC | | 9365 WASHINGTON ST LOCKPORT IL 60441 | 07/23/2018 | 07/23/2023 |
| DOL | DOL | *****0440 | SOLAR GUYS INC. | | 8970 MIKE GARCIA DR MANASSAS VA 20109 | 07/16/2021 | 07/16/2026 |
| DOL | NYC | | SOMATIE RAMSUNAHAI | | 115-46 132ND ST SOUTH OZONE PARK NY 11420 | 09/17/2020 | 09/17/2025 |
| DOL | DOL | *****2221 | SOUTH BUFFALO ELECTRIC, INC. | | 1250 BROADWAY ST BUFFALO NY 14212 | 02/03/2020 | 02/03/2025 |
| DOL | NYC | *****3661 | SPANIER BUILDING MAINTENANCE CORP | | 200 OAK DRIVE SYOSSET NY 11791 | 03/14/2022 | 03/14/2027 |
| DOL | DOL | | STANADOS KALOGELAS | | 485 RAFT AVENUE HOLBROOK NY 11741 | 10/19/2021 | 10/19/2026 |
| DOL | DOL | *****3496 | STAR INTERNATIONAL INC | | 89-51 SPRINGFIELD BLVD QUEENS VILLAGE NY 11427 | 08/11/2003 | 08/11/3003 |
| DOL | DOL | *****6844 | STEAM PLANT AND CHX SYSTEMS INC. | | 14B COMMERCIAL AVENUE ALBANY NY 12065 | 11/14/2019 | 11/14/2024 |
| DOL | DOL | *****9933 | STEED GENERAL CONTRACTORS, INC. | | 1445 COMMERCE AVE BRONX NY 10461 | 05/30/2019 | 05/30/2024 |
| DOL | DOL | *****9528 | STEEL-IT, LLC. | | 17613 SANTE FE LINE ROAD WAYNESFIELD OH 45896 | 07/16/2021 | 07/16/2026 |
| DOL | DOL | | STEFANOS PAPASTEFANOU, JR. A/K/A STEVE PAPASTEFANOU, JR. | | 256 WEST SADDLE RIVER RD UPPER SADDLE RIVER NJ 07458 | 05/30/2019 | 05/30/2024 |
| DOL | DOL | | STEVE TATE | | 415 FLAGER AVE #302STUART FL 34994 | 10/31/2018 | 10/31/2023 |
| DOL | DOL | | STEVEN MARTIN | | 2404 DELWARE AVE NIAGARA FALLS NY 14305 | 09/12/2018 | 09/12/2023 |
| DOL | DOL | *****3800 | SUBURBAN RESTORATION CO. INC. | | 5-10 BANTA PLACE FAIR LAWN PLACE NJ 07410 | 03/29/2021 | 03/29/2026 |
| DOL | DOL | *****1060 | SUNN ENTERPRISES GROUP, LLC | | 370 W. PLEASANTVIEW AVE SUITE 2.329HACKENSACK NJ 07601 | 02/11/2019 | 02/11/2024 |
| DOL | DOL | *****9150 | SURGE INC. | | 8269 21ST STREET BELLEROSE NY 11426 | 12/22/2022 | 12/22/2027 |
| DOL | DOL | | SYED RAZA | | 198 RIDGE AVENUE NY 11581 | 06/06/2022 | 06/06/2027 |
| DOL | DOL | *****8209 | SYRACUSE SCALES, INC. | | 158 SOLAR ST SYRACUSE NY 13204 | 01/07/2019 | 01/07/2024 |
| DOL | DOL | | TERRY THOMPSON | | 11371 RIDGE RD WOLCOTT NY 14590 | 02/03/2020 | 02/03/2025 |
| DOL | DOL | *****9733 | TERSAL CONSTRUCTION SERVICES INC | | 107 FACTORY AVE P.O BOX 11070SYRACUSE NY 13208 | 07/16/2021 | 07/16/2026 |
| DOL | DOL | | TERSAL CONTRACTORS, INC. | | 221 GARDNER RD P.O BOX 14POMPEI NY 13138 | 07/16/2021 | 07/16/2026 |
| DOL | DOL | | TERSAL DEVELOPMENT CORP. | | 1935 TEALL AVENUE SYRACUSE NY 13206 | 07/16/2021 | 07/16/2026 |
| DOL | DOL | | TEST | | P.O BOX 123 ALBANY NY 12204 | 05/20/2020 | 05/20/2025 |
| DOL | DOL | *****6789 | TEST1000 | | P.O BOX 123 ALBANY NY 12044 | 03/01/2021 | 03/01/2026 |
| DOL | DOL | *****5766 | THE COKER CORPORATION | COKER CORPORATION | 2610 SOUTH SALINA ST SUITE 14SYRACUSE NY 13205 | 12/04/2018 | 12/04/2023 |
| DOL | DOL | *****5766 | THE COKER CORPORATION | COKER CORPORATION | 2610 SOUTH SALINA ST SUITE 14SYRACUSE NY 13205 | 09/17/2020 | 09/17/2025 |
| DOL | DA | *****4106 | TRIPLE H CONCRETE CORP | | 2375 RAYNOR STREET RONKONKOMA NY 11779 | 08/04/2021 | 08/04/2026 |
| DOL | DOL | *****8210 | UPSTATE CONCRETE & MASONRY CONTRACTING CO INC | | 449 WEST MOMBASHA ROAD MONROE NY 10950 | 06/06/2022 | 06/06/2027 |
| DOL | DOL | *****6392 | V.M.K CORP. | | 8617 THIRD AVE BROOKLYN NY 11209 | 09/17/2018 | 09/17/2023 |
| DOL | DOL | *****6418 | VALHALLA CONSTRUCTION, LLC. | | 796 PHELEPS ROAD FRANKLIN LAKES NJ 07417 | 12/01/2020 | 12/01/2025 |

NYSDOL Bureau of Public Work Debarment List 04/03/2023

Article 8

| | | | | | | | |
|-----|-----|-----------|---------------------------------------|------------------------------|--|------------|------------|
| DOL | NYC | *****2426 | VICKRAM MANGRU | VICK CONSTRUCTI ON | 21 DAREWOOD LANE VALLEY STREAM NY 11581 | 09/17/2020 | 09/17/2025 |
| DOL | NYC | | VICKRAM MANGRU | | 21 DAREWOOD LANE VALLEY STREAM NY 11581 | 09/17/2020 | 09/17/2025 |
| DOL | DOL | | VICTOR ALICANTI | | 42-32 235TH ST DOUGLASTON NY 11363 | 01/14/2019 | 01/14/2024 |
| DOL | NYC | | VIKTAR PATONICH | | 2630 CROPSY AVE BROOKLYN NY 11214 | 10/30/2018 | 10/30/2023 |
| DOL | DOL | | VIKTORIA RATH | | 24 ELDOR AVENUE NEW CITY NY 10956 | 02/03/2020 | 02/03/2025 |
| DOL | NYC | *****3673 | WALTERS AND WALTERS, INC. | | 465 EAST AND THIRD ST MT. VERNON NY 10550 | 09/09/2019 | 09/09/2024 |
| DOL | DOL | *****3296 | WESTERN NEW YORK CONTRACTORS, INC. | | 3841 LAYNARD COURT NEW PORT RICHEY FL 34652 | 07/09/2019 | 07/09/2024 |
| DOL | DOL | | WHITE PLAINS CARPENTRY CORP | | 442 ARMONK RD | 06/12/2018 | 06/12/2023 |
| DOL | DOL | | WILLIAM G. PROERFRIEDT | | 85 SPRUCEWOOD ROAD WEST BABYLON NY 11704 | 01/19/2021 | 01/19/2026 |
| DOL | DOL | *****5924 | WILLIAM G. PROPHY, LLC | WGP CONTRACTIN G, INC. | 54 PENTAQUIT AVE BAYSHORE NY 11706 | 01/19/2021 | 01/19/2026 |
| DOL | DOL | *****4730 | XGD SYSTEMS, LLC | TDI GOLF | 415 GLAGE AVE #302STUART FL 34994 | 10/31/2018 | 10/31/2023 |

GENERAL CONDITIONS

NOTE: The headings of the articles herein are intended for the convenience of reference only and shall not be considered as having any bearing on their interpretation.

PART 1

101 DEFINITIONS

Whenever used in any of the Contract Documents, the following meanings shall be given to the terms herein defined:

- a. The term "Contract" means the Contract executed by the Owner and the Contractor.
- b. The term "Owner" means the Village, which is authorized to undertake this Contract.
- c. The term "Contractor" means the person, firm or corporation entering into the Contract with the Owner to perform and complete the work involved in this Contract.
- d. The term "Subcontractor" means a person, firm or corporation supplying labor and materials or only labor for work at the site of the project for, and under separate contract or agreement with the Contractor.
- e. The term "Project Area" means the area shown on the drawing in the immediate vicinity of the work, unless otherwise defined in the Special Conditions. No private property is included unless the Village has obtained an easement.
- f. The term "Engineer" or "Architect" means the Village Engineer of the Village, or such of his subordinates or assistants as have Project Engineer status: or if a Consulting Engineer is employed to perform construction management and inspection then this term shall apply to said Consulting Engineer and those subordinates and assistants that have Project Engineer status. A list of authorized Project Engineers will be furnished to the Contractor on request.
- g. The term "Village" means the Village, New York, within which the Project Area is situated.
- h. The term "Contract Documents" means and shall include the Documents listed in Article 3 of the Agreement.
- i. The term "Drawings" or "Contract Drawings" means the drawings listed in the Schedule of Drawings.
- j. The term "Technical Specifications" or "Supplemental Technical Specifications" means that part of the Contract Documents which describes, outlines and stipulates, the quality of materials to be furnished; the quality of workmanship required; measurement and payment.
- k. The term "Addendum" or "Addenda" means any changes, revisions or clarifications of the Contract Documents which have been duly issued by the Owner to prospective Bidders prior to the time of receiving Bids.

102 SUPERINTENDENCE BY CONTRACTOR

- a. Except where the Contractor is an individual and gives his personal superintendence to the work the Contractor shall provide a competent superintendent, satisfactory to the Owner, for the work at all times during working hours with full authority to act for him. The Contractor shall also provide an adequate staff for the proper coordination and expediting of his work. Should, in the opinion of the Owner, any language barrier exist between the superintendent and the Owner, the Contractor shall furnish a qualified interpreter.
- b. The Contractor shall lay out his own work including all survey required and he shall be responsible for all work executed by him under the Contract. He shall verify all figures, elevations, etc. before proceeding with the work or ordering materials and will be held responsible for any error resulting from his failure to do so and will correct same to the satisfaction of the Village at no additional cost.

103 SUBCONTRACTS

- a. The Contractor shall not execute an agreement with any Subcontractor or permit any Subcontractor to perform any work included in this Contract until he has received written approval of such Subcontractor from the Owner.
- b. The Contractor shall be as fully responsible to the Owner for the acts and omissions of his Subcontractors, and of persons either directly or indirectly employed by them as he is for the acts and omissions of persons directly employed by him. All subcontractors must have adequate superintendence on the work site when they are performing work.
- c. The Contractor shall cause appropriate provision to be inserted in all Subcontracts relative to the work to require compliance by each subcontractor with the applicable provisions of the Contract for the work embraced in this Contract.
- d. Nothing contained in the Contract shall create any contractual relation between any Subcontractor and the Owner.
- e. The Contractor shall not subcontract more than 50% of the total work of this contract.

104 OTHER CONTRACTS

The Owner reserves the right to let other Contracts in connection with this work or to perform work related to this project with his own forces. The Contractor shall offer other Contractors and the Owner reasonable opportunity for the introduction and storage of their materials and the execution of their work, and shall properly connect and/or coordinate his work with theirs. The Contractor shall cooperate fully with such other Contractors, by scheduling his own work with that to be performed under other Contracts as may be directed by the Owner. The Contractor shall not permit or commit any act which will interfere with the performance of work by any other Contractor as scheduled.

Wherever work being done by the Village or Municipal forces, or other Contractors is contiguous to work covered by this contract, the respective rights of the various interests involved shall be

established by the Owner, to secure the completion of the various portions of the work in general harmony.

If any part of the Contractor's work depends for proper execution or results upon the work of others, the Contractor shall inspect and promptly report to the Engineer in writing any defects or deficiencies in such work that render it unsuitable for such proper execution and results.

105 RESPONSIBILITIES OF CONTRACTOR

Except as otherwise specifically stated in the Contract Documents, the Contractor shall provide and pay for all materials, labor, tools, equipment, water, light, heat, power, transportation, superintendence, temporary construction of every nature, charges, levies, fees or other expenses and all other services and facilities of every nature whatsoever necessary for the performance of the Contract and to complete this Contract in every respect within the specified time.

106 FITTING AND COORDINATION OF THE WORK

The Contractor shall be responsible for the proper fitting of all work and for the coordination of the operations of all trades, Subcontractors or Suppliers engaged upon this Contract. He shall be prepared to guarantee to each of Subcontractors, the locations and measurements which they may require for the fitting of their work to all surrounding work. The Contractor shall, at his own expense, effect all cutting, fitting, or patching of his work required to make the same conform to the Contract Drawings and specifications and except with the consent of the Owner, not to cut or otherwise alter the work of any other Contractor.

107 MUTUAL RESPONSIBILITY OF CONTRACTOR

If, through acts or neglect on the part of the Contractor, any other Contractor or Subcontractor shall suffer loss or damage on the work, the Contractor shall settle with such other Contractor or Subcontractor by agreement or arbitration, if such other Contractor or Subcontractor will so settle. If such other Contractor or Subcontractor shall assert any claim against the Owner on account of any damage alleged to have been so sustained, the Owner will notify the Contractor, who shall defend at his own expense any suit bared upon such claim, and, in any judgment or claims against the Owner shall pay or satisfy such judgment or claim and pay all costs and expenses in connection therewith and will in all other respects, including, but not limited to attorney's fees and court costs, hold harmless the Owner and Engineer.

108 ASSIGNMENT OR NOVATION

The Contractor shall not assign or transfer, whether by an assignment or novation, any of its rights, duties, benefits, obligations, liabilities or responsibilities under this Contract without the written consent of the Owner; provided, however, that assignments to banks, trust companies, or other financial institutions may be made without the consent of the Owner. No assignment or novation of this Contract shall be valid unless the assignment or novation expressly provides that the assignment of any of the Contractor's rights or benefits under the Contract is subject to a prior lien for labor performed, services rendered and materials, tools and equipment supplied for the performance of the work under this Contract in favor of all persons, firms or corporations rendering such labor or services or supplying such materials, tools or equipment.

109 PROGRESS SCHEDULE

The Contractor shall submit within seven (7) calendar days after award a carefully prepared realistic Progress Schedule showing the proposed dates of starting and completing of each and every item of work on each and every section of work in accordance with these Specifications if applicable to this specific Contract. The Progress Schedule shall include as a minimum:

- a. The project name, number and geographic location.
- b. The contract time, contract beginning date and ending date.
- c. The time of beginning and completion of each significant phase of this contract.

The initial requisition will not be approved for payment until said schedule is submitted. Said schedule will be revised or updated monthly unless otherwise permitted by the Owner. No monthly payments will be approved without a revised/updated monthly Progress Schedule approved by the Owner.

The Progress Schedule shall show the plan of construction and the proposed method of carrying out this work including a full statement of the equipment to be used.

110 COMMUNICATIONS

- a. All notices, demands, requests, instructions, approvals, proposals and claims must be in writing.
- b. Any notice to or demand upon the Contractor shall be sufficiently given if delivered at the office of the Contractor stated on the signature page of the Agreement (or at such other office as the Contractor may from time to time designate) in a sealed, postage prepaid enveloped or delivered with charges prepaid to any telegraph company for transmission, in each case addressed to such office.
- c. All papers required to be delivered to the Owner shall, unless otherwise specified in writing to the Contractor, be delivered to the Village Engineer, Hastings-on-Hudson Municipal Building, 7 Maple Avenue, Hastings-on-Hudson, New York, and any notice to or demand upon the Owner shall be sufficiently given if so delivered, or if deposited in the United States mail in a sealed, postage-prepaid envelope, or delivered with charges prepaid to any telegraph company for transmission to said Owner at such address, or to such other representatives of the Owner or to such other address as the Owner may subsequently specify in writing to the Contractor for such purpose.
- d. Any such notice shall be deemed to have been given as of the time of actual delivery or (in case of mailing) when the same should have been received in due course of post, or in the case of telegrams, at the time of actual receipt, as the case may be.

111 PAYMENTS TO CONTRACTOR

- a. Partial Payments
 1. The Engineer shall prepare an estimate of the work performed for partial payment as of a mutually agreed upon date at least 30 days after the beginning of work, and

approximately every 30 days thereafter. The amount of the payment due the Contractor shall be determined by adding the total value of work completed to date and deducting (1) five percent (5%) of the total amount, to be retained until final payment and (2) the amount of all previous payments. The total value of work completed to date shall be based on the estimated quantities of work completed and on the unit prices, if any, contained in the Agreement.

2. There will be no payments or partial payments to the Contractor for materials purchased and stored/stockpiled on the project site.

Monthly or partial payments made by the Owner to the Contractor are monies advanced for the purpose of assisting the Contractor to expedite the work of construction. All material and completed work covered by such monthly or partial payments shall remain the property of the Contractor and he shall be responsible for the care and protection of all materials and work upon which payments have been made. Such payments shall not constitute a waiver of the right of the Owner to require the fulfillment of all terms of the Contract and the delivery of all improvements embraced in this Contract complete and satisfactory to the owner in all details.

b. Final Payment

1. After final inspection and acceptance by the Owner of all work under the Contract, the Contractor shall prepare his requisition for final payment which shall be based upon the carefully measured or computed unit prices stipulated in the Agreement. The total amount of the final payment due the Contractor under this Contract shall be the amount computed without retainage less all previous payments. Final payment to the Contractor shall be made subject to his furnishing the Owner with a release in satisfactory form of all claims against the Owner, arising under and by virtue of his Contract, other than such claims, if any, as may be specifically accepted by the Contractor from the operation of the release as provided elsewhere herein.
2. The Owner, before paying the final estimate, may require the Contractor to furnish releases or receipts from all subcontractors having performed any work and all persons having supplied materials, equipment (installed on the Project) and services to the Contractor, if the Owner deems the same necessary in order to protect its interior. The Owner, however, may if it deems such action advisable, make payment in part or in full to the Contractor without requiring the furnishing of such releases or receipts of any payment so made shall in no way impair the obligations of any surety or sureties furnished under this Contract.
3. The Contractor shall furnish a maintenance bond in full amount of the Contract plus change orders, if any, to guarantee his work for a period of one (1) year from the date of final payment.
4. If it was necessary for the Owner to expend money for labor, materials or equipment on this project because the Contractor failed to perform satisfactorily or promptly, and a bill for such sum remains unpaid, the Owner may deduct this sum

from partial payments or the final payment. Furthermore, if the specifications provide for certain work to be done by the Owner with the fee or cost to be borne by the Contractor, and a bill for such services remains unpaid, the Owner may deduct this sum from the partial or the final payment.

5. Withholding of any amount due the Owner under the section entitled "LIQUIDATED DAMAGES" shall be deducted from the final payment due the Contractor. At the Owner's option, liquidated damages may be deducted from any partial payment.

c. Withholding Payments

Notwithstanding the above, the Owner may withhold from any payment otherwise due the Contractor so much as may be necessary to protect the Owner and if it so elects may also withhold any amounts due from the Contractor to any Subcontractors or material dealers, for work performed or material furnished by them. The foregoing provisions shall be construed solely for the benefit of the Owner and will not require the Owner to determine or adjust any claims or disputes between the Contractor and his Subcontractors or material dealers, or to withhold any monies for their protection unless the Owner elects to do so. The failure or refusal of the Owner to withhold any monies from the Contractor shall in no way impair the obligations of any surety or sureties under any bond or bonds furnished under this Contract.

d. Payments Subject to Submission of Certificates

Each payment to the Contractor by the Owner shall be made subject to submission by the Contractor of all written certifications required of him and his Subcontractors by the Section entitled CONTRACTOR'S CERTIFICATES under the GENERAL CONDITIONS.

112 CHANGES IN THE WORK

- a. The Owner may make changes in the work required to be performed by the Contractor under the Contract by making additions thereto, or by omitting work therefrom, without invalidating the Contract.
- b. Except for the purpose of affording protection against any emergency endangering life or property, the Contractor shall make no change in the materials used or in the specified manner of constructing and/or installing the improvements or supply additional labor, services or materials beyond that actually required for the execution of the Contract, unless in pursuance of a written order from the Owner authorizing the Contractor to proceed with the change. No claim for an adjustment of the Contract price will be valid unless so ordered.
- c. The Contractor agrees to perform any of the aforementioned changed work, along with all other required work found under the Contract, without delay and in accordance with good construction practices.
- d. These changes outlined above may be made without relieving or releasing the Contractor

from any of his obligations under the Contract provisions, and without affecting the validity of the guaranty bonds, and without relieving or releasing the surety or sureties of said bonds. All such work shall be executed under the terms of the original Contract unless it is provided otherwise.

- e. All adjustments to the Contract payment provisions will be made in accordance with the following paragraphs.
- f. If applicable unit prices are contained in the Agreement (established as a result of either a Unit Price Bid or a Supplemental Schedule of Unit Prices), the Owner may order the Contractor to proceed with desired changes in the work, the value of such changes to be determined by the measured quantities involved and the applicable unit prices specified in the Contract. Payment for unit price overruns, due to change orders, may be withheld until Village Board approval is obtained.
- g. If applicable unit prices are not contained in the Agreement, the Owner shall, before ordering the Contractor to proceed with desired changes, request and itemized proposal from him covering the work involved in the change after which the procedure shall be as follows:
 - 1. If the change in the work involves additional work, the procedure shall be as follows:
 - (a) If the proposal is acceptable, the Owner will prepare the Change Order in accordance therewith for acceptance by the Contractor; or
 - (b) If the proposal is not acceptable and prompt agreement between the two parties cannot be reached, the Owner may order the Contractor to proceed with the work on a Cost-Plus Basis. A Cost-Plus Basis is defined as the net cost of the work to the Contractor plus an allowance to cover overhead and profit as stipulated below:

“Net cost of the work” is defined as (1) gross cost of labor plus (2) net cost of materials plus (3) gross cost of equipment.

- (1) “Gross cost of labor” is defined as net cost of labor plus fringe benefits.

“Net cost of labor” is defined as the cost of required labor based on the prevailing rates established by the State Labor Department and stated in the Contract Document. No part of any salary for employees above the grade of foremen, and having general supervision of this work, will be included in this item.

“Fringe benefits” are defined as all insurances, taxes and other benefits for the employee required by law or by union contract. In lieu of an item-by-item determination of the actual value of such fringe benefits, all fringe benefits are hereby determined to total an amount of 40% of net cost of labor, and the Contractor in submitting his bid agrees that this percentage shall be used, regardless of whether actual fringe benefits are more or less than this amount.

- (2) “Net cost of materials” shall be defined as the cost of all materials incorporated in the work, including delivery charges, less any allowable cash discounts, as shown by receipted bills.
- (3) “Gross cost of equipment” is defined as the “net cost of equipment” plus an allowance of 10% for fuel and lubricants.

“Net cost of equipment” shall be defined as a rental rate which is reasonable and based on rental rates prevailing in the area where the work is to be done. Such rental rate shall be negotiated, and shall be agreed upon in writing before the work is begun. However, in no case shall the rental rates exceed the rates set forth in the current edition of the “Associated Equipment Distributors Compilation of Rental Rates for Construction Equipment.” The cost of furnishing small tools and accessories and materials used for construction but not incorporated in the work shall be considered as part of the Contractor’s overhead, and shall not be included in the “net cost of the work.”

An allowance of 15% will be added for overhead and profit to “gross cost of labor” and “Net cost of Materials” and is hereby stipulated to be in lieu of an actual determination of overhead and profit. The Contractor in submitting his bid agrees that this allowance shall be used, regardless of whether actual overhead and profit is more or less than this amount.

No percentage for overhead and profit shall be added to the amounts of equipment rental prices agreed upon, but the price agreed upon shall be the total compensation allowed for use of such equipment.

2. If the change in the work requires a reduction in the work involved, the procedure shall be as follows:
 - (a) If the proposal is acceptable, the Owner will prepare the Change Order in accordance therewith for acceptance by the Contractor; or
 - (b) If the proposal is not acceptable and prompt agreement between the two parties cannot be reached, the Engineer shall fix the cost value of the credit. The Owner may then order the Contractor to proceed with the work. Should the Contractor disagree with the cost value of the credit as fixed by the Engineer, he may appeal the same in accordance with the procedures outlined in the GENERAL CONDITIONS.

i. Each Change Order shall include in its final form:

1. A detailed description of the change in the work.
2. The Contractor’s proposal (if any) or a confirmed copy thereof.
3. A definite statement as to the resulting change in the Contract price and/or time.
4. The statement that the Change Order is subject to the approval of the Village Board.

- j. Contractor shall not take advantage of any obvious error in the specifications or any such error in the drawings or other Contract Documents. Any obvious error or discrepancy in or between any of the Contract Documents shall be immediately reported to the Engineer who shall make such corrections and interpretations as may be deemed necessary for the completion of the work in a satisfactory and acceptable manner.
- k. Change Orders shall in general be in writing. If a Contractor claims that a change order was given to him orally, his claim shall be invalid unless such oral change order was given by an authorized Engineer as defined in Section 101f. of this Contract, and further unless such oral change order was confirmed in writing within 24 hours of the giving of the alleged oral change order.
- l. When change orders, or claims involve a Subcontractor, no surcharge will be allowed the Contractor for handling, processing, supervision, or coordination.

113 CLAIMS FOR EXTRA COST

- a. All claims between the parties, including all claims for additional compensation and/or additional time, arising out of, or in any way related to this Contract and/or the performance of the same, or its interpretation shall within ten (10) days of the event or action giving rise to the claim be presented to the Engineer. All papers pertaining to claims shall be filed in quadruplicate. Such notice need not detail the amount of the claim but shall state the facts surrounding the claim in sufficient detail to identify the claim, together with its character and scope. In the meantime, the Contractor shall proceed with the work as directed. Any claim not presented within the time limit specified in this paragraph shall be deemed to have been waived, except that if the claim is of a continuing character and notice of the claim is not given within ten (10) days of its commencement, the claim will be considered only for a period commencing ten (10) days prior to the receipt by the Engineer of notice thereof. The Contractor shall in no case allow any claim or dispute to delay the work.
- b. As soon as practicable after the final submission of all information the Owner shall make a determination of any claim. Said decision of the Owner shall be a condition precedent to any further action on the claim. However, upon certification in writing by the claimant that the claim has been submitted in its final form, the Owner shall be obliged to render a decision on said claim within sixty (60) days of the date of said certification. Should the Owner fail to render its decision within the aforementioned sixty (60) day period, its decision will not be a condition precedent to any further action on the part of the claimant.
- c. There shall be no added compensation paid for delay to the Contractor unless the Owner causes said delay by a material breach of this Contract, and compliance with the foregoing notice provisions shall be a condition precedent to the prosecution of any such claim. In any claim for delay except for "Excusable Delays and Extensions of Time" as defined in the GENERAL CONDITIONS SECTION "TERMINATION"; "DELAYS AND EXTENSIONS"; "LIQUIDATED DAMAGES" wherein it is alleged that the Contractor's equipment was caused to remain idle, only one half of the prevailing rental rates for use of said equipment will be considered as damages for idled equipment in order to allow for the absence of fair wear and tear, which is allowed for in prevailing rental rates for equipment usage.

- d. Claims for additional compensation for extra work, due to alleged errors in ground elevations, contour lines, or bench marks, will not be considered unless accompanied by certified survey data, made prior to the time the original ground was disturbed, clearly showing that errors exist which resulted, or would result, in handling more material, or performing more work, than would be reasonably estimated from the Drawings and maps issued.
- e. If, on the basis of the available evidence, the Owner determines that an adjustment of the Contract Price and/or Time is justifiable, the procedure shall be as provided in Sections - "CHANGES IN THE WORK" or "TERMINATIONS; DELAYS AND EXTENSIONS; LIQUIDATED DAMAGES" of the GENERAL CONDITIONS.
- f. In the event of an unfavorable decision by the Owner, the Contractor shall have the right to contest said decision as provided for under the provisions of this Contract.

114 NO OPTIONS PAID

It shall be clearly understood that there will be no payment for materials incorporated into the work (other than that shown on the Contract Drawings or specified) unless ordered by the Engineer.

115 TIME AND MATERIALS WORK NOTIFICATION

Should the Contractor perform work in accordance with the General Conditions, "CHANGES IN THE WORK", he shall give a minimum of 24 hours advance written notice prior to his anticipated beginning any work on a Cost-Plus Basis, to the Owner and specifically the Village Engineer.

116 TERMINATION; DELAYS AND EXTENSIONS; LIQUIDATED DAMAGES

- a. Termination of Contract. For its own convenience the Owner may, at any time prior to the issuance of a Notice to Proceed, void the Contract by giving unequivocal and unconditional written notice of such avoidance to the Contractor and in the event of such avoidance the Owner will not be liable to the Contractor for any claims or losses including anticipated loss of profit and monies expended in anticipation of performance under the Contract.

At any time subsequent to the Notice to Proceed the Owner may, at its own convenience, terminate the Contract by giving unequivocal and unconditional written notice of such termination to the Contractor. In the event of such termination by the Owner, the Owner shall be responsible to the Contractor for the following monies only, which monies shall be subject to legitimate charges of the Owner against the Contractor:

- 1. All reasonable costs incurred by the Contractor in performance of or in anticipation of performance of the Contract provided the Contractor shall take all reasonable steps to mitigate such damages including the return and/or re-sale of materials ordered; and
- 2. On Lump Sum projects, a mark-up of 10% for profit and 10% for overhead on the reasonable cost of the work that is completed and in place in accordance with the Contract Drawings and Specifications will be allowed. On unit price contracts,

allowances for profit and overhead shall be considered to have been included in each of the Contractor's original unit price bid. The Contractor shall remain responsible for the work completed, in accordance with the Contract provisions.

Should any work under this contract be subject to, or terminated by the action of any third party, governmental unit or court due to any ecological or other reason the rights of the Contractor to recover from the Owner shall be determined as set forth above.

The Owner may give notice in writing to the Contractor and his Surety of any material breach of the Contract by the Contractor to include but not be limited to any of the following:

- (a) Failure to begin the work under the Contract within the time specified.
- (b) Failure to perform the work with sufficient workmen, equipment or materials to insure the prompt completion of said work.
- (c) Unsuitable performance of the work or failure to perform anew such work as shall be rejected as defective and unsuitable.
- (d) Neglecting or refusing to remove material rejected as defective and unsuitable.
- (e) Discontinuing the suitable prosecution of the work for a period of 72 hours, excluding Sundays and holidays without written authorization of the Engineer.
- (f) Failure to commence discontinued work within 48 hours after notice to resume (excluding Sundays and holidays).
- (g) Becoming insolvent or declared bankrupt or commits any act of bankruptcy or insolvency.
- (h) Allowing any final judgment to stand against him unsatisfied for a period of ten (10) calendar days.
- (i) Making any assignment for the benefit of creditors.
- (j) Violating any covenants contained in the Contract Documents.
- (k) Failure to eliminate unsafe conditions within 12 hours.

The Contractor or Surety within a period of ten (10) calendar days after such notice shall take all practical action to correct said material breach. Should said action fail to meet with the approval of the Owner, the Owner may, at its discretion, order the Surety to complete the work or, without violating the Contract, take the prosecution of the work out of the hands of said Contractor and Surety.

The Owner may appropriate or use any or all materials and equipment on the ground as may be suitable and acceptable and may enter into an agreement, either by negotiation or public letting, for the completion of said Contract according to the terms and provisions thereof, or use such other methods or combinations thereof, as in its opinion shall be required or desirable for the completion of said Contract in an acceptable manner. All costs and charges incurred by the Owner together with the cost of completing the work under Contract shall be deducted from any monies due or which may become due said Contractor. In case such expense shall exceed the sum which would have been payable under the Contract, then the Contractor and the Surety shall be liable and shall pay to the Owner the amount of said excess.

b. Excusable Delays and Extensions of Time. The right of the Contractor to proceed shall not be terminated nor shall the Contractor be charged with liquidated damages for any delays in the completion of the work due:

1. To any acts of the Government, including controls or requisitioning of materials, equipment, tools, or by labor by reason of war, National Defense, or any other national emergency.
2. To any acts of the Owner caused an injunction or litigation against said Owner, by a third party.
3. To causes not reasonably foreseeable by the parties to this Contract at the time of the execution of the Contract which are beyond the control and without the fault or negligence of the Contractor, including, but not restricted to, acts of God or of the public enemy, acts of another Contractor in the performance of some other Contract with the Owner, fires, floods, epidemics, quarantine, restrictions, strikes, freight embargoes, and weather of unusual severity such as hurricanes, tornadoes, cyclones and other extreme weather conditions; and
4. To any delay of any Subcontractor occasioned by any of the causes specified in subparagraphs 1, 2 and 3 of this paragraph "b".

Provided, however, that the Contractor promptly notify the Owner within ten (10) days in writing of the cause of the delay. Upon receipt of such notification, the Owner shall ascertain the facts and the cause and extent of delay. If, upon the basis of the Facts and the terms of this Contract, the delay is properly excusable, the owner shall extend the time for completing the work for a period of time commensurate with the period of excusable delay.

No claim for damages or any claim other than for an extension of time as herein provided shall be made or asserted against the Owner or Village by reason of any delay.

c. Liquidated Damages for Delay. If the work is not completed within the time stipulated in Section - TIME OF COMPLETION under SPECIAL CONDITIONS, including any extensions of time for excusable delays as herein provided, the Contractor shall pay to the Owner as fixed, agreed, and as liquidated damages (it being impossible to determine the

actual damages occasioned by the delay) for each calendar day of delay, until the work is completed, the amount as set forth in Section - LIQUIDATED DAMAGES under SPECIAL CONDITIONS and the Contractor and his sureties shall be liable to the Owner for the amount thereof. Neither permission given by the Owner for the Contractor to continue the work after the time fixed for completion, nor the inspection and acceptance of such work, shall be deemed a waiver on the part of the Owner of any of his rights under this Contract.

117 ENGINEER'S AUTHORITY

The Engineer will decide all questions which may arise in relation to the work and the construction thereof. The Engineer's estimates and decisions shall be final and conclusive, except as herein otherwise expressly provided. In case any question shall arise between the parties hereto relative to said Contract, the determination or decision of the Engineer shall be a condition precedent to the right of the Contractor to receive any money or payment for work under this Contract affected in any manner or to any extent by such question.

118 TECHNICAL SPECIFICATIONS AND CONTRACT DRAWINGS

Anything mentioned in the Technical Specifications and not shown on the Contract Drawings or shown on the Contract Drawings and not mentioned in the Technical Specifications shall be of like effect as if shown on or mentioned in both. In case of difference between the Contract Drawings and Technical Specifications, the Technical Specifications shall govern. In case of any discrepancy within the Contract Drawings or within the Technical Specifications, the matter shall be immediately submitted to the Owner without whose decision said discrepancy shall not be adjusted by the Contractor, save only at his own risk and expense.

119 REQUESTS FOR SUPPLEMENTARY INFORMATION

It shall be the responsibility of the Contractor to make timely requests of the Owner for any additional information not already in his possession which should be furnished by the Owner under the terms of this Contract, and which he will require in the planning and execution of the work. Such requests may be submitted from time to time as the need is approached, but each shall be filed in ample time to permit appropriate action to be taken by all parties involved so as to avoid delay. Each request shall be in writing, and list the various items and latest date by which each will be required by the Contractor. The first list shall be submitted within two (2) weeks after Contract award and shall be as complete as possible at that time. The Contractor shall, if requested, furnish promptly any assistance and information the Engineer may require in responding to these requests of the Contractor. The Contractor shall be fully responsible for any delay in his work or to others arising from his failure to comply fully with the provisions of this Section.

120 SHOP DRAWINGS

Shop drawings are required for all manufactured items. In the case of reinforced concrete, details of reinforcing bars and form construction and materials shall be submitted in the same manner as shop drawings.

- a. All required shop drawings, machinery details, layout drawings, working drawings, material and equipment descriptions, etc., shall be submitted to the Engineer in three (3)

copies for review sufficiently in advance of requirements to afford ample time for checking, including time for correcting, resubmitting and rechecking if necessary. Two (2) weeks should be allowed for checking from the date of receipt by the Engineer. The Contractor, with the approval of the Engineer, may submit manufacturer's literature as a substitute for, or supplement to, the shop drawings, etc. The minimum size for any submission shall be 8-1/2" x 11" and the maximum size shall be 24" x 36".

- b. No construction, purchase, delivery, installation or work shall be done or made on any part or feature of this Contract which is dependent upon shop drawing review, until such review has been received from the Engineer. If the Contractor proceeds without reviewed shop drawings, it shall be at his own risk. No claim by the Contractor, for extension of the Contract time will be granted by reason of his failure in this respect.
- c. Shop drawings, etc., or printed matter shall give all dimensions, sizes, etc. to enable the Engineer to determine suitability of the construction, installation, material or layout for the purposes intended. Where needed for clarity, the drawings shall include outline, sectional views and detailed working dimensions and designations of the kind of material, machine work, finish, etc., required. The drawings to be submitted shall be coordinated by the Contractor with any other drawings previously reviewed, with the design and function of any equipment or structure and the Contract Drawings.
- d. By submitting shop drawings, etc., the Contractor thereby represents that he has determined and verified all field measurements, field construction criteria, materials, catalog numbers and similar data, or will do so and that he has checked and coordinated each shop drawing, etc. with the requirements of the work and of the Contract Documents.
- e. If any drawings show variations from the requirements of the Contract because of standard shop practice and/ or other reasons, the Contractor shall make specific mention of such variation in his letter of transmittal in order that, if acceptable, suitable action may be taken for proper adjustment of the contract price and/ or time; otherwise, the Contractor will not be relieved of the responsibility for executing the work in accordance with the Contract even though the drawings have been reviewed.
- f. After review, the submittals will be stamped "Approved," "Approved as Noted," "Resubmit," or "Disapproved." Two (2) prints of "Approved" or "Approved as Noted" drawings will be returned to the Contractor for his use and distribution to his suppliers and/or Subcontractors. In the case of those stamped "Resubmit" or "Disapproved" two (2) prints will be returned to the Contractor who shall make all indicated corrections and resubmit (3) prints.
- g. In any submission which is noted as "Approved" or "Approved as Noted," the review shall not extend to details or dimensions and shall not relieve the Contractor from his responsibility for compliance with the Contract Drawings and specifications.
- h. When the Contractor proposes a revision to a previously submitted shop drawing, etc., three (3) copies shall be resubmitted for review. This re-submittal shall clearly indicate, in a revision block, the date, description and location of the revision. The letter of transmittal shall state the reasons for the revision.

- i. The Contractor shall furnish as many copies of the submittals as is necessary for the proper coordination of the work, and shall maintain a complete set of the reviewed submissions at the site of the work at all times.
- j. Upon the final acceptance of the project, the Contractor shall, on request, furnish the Owner with a complete set of shop drawing tracings or reproducible cloth reproductions of the shop drawing tracings.
- k. There will be no direct payment made for any of the above submittals, or reproducible drawings if required, but the cost thereof shall be considered as included in the general cost of the work.

121 SAMPLES, CERTIFICATES AND TESTS

- a. The Contractor shall submit all samples, materials, certified test reports, materials certificates, certificates of compliance, affidavits, etc., as called for in the Contract Documents or required by the Engineer, promptly after award of the Contract and acceptance of the Contractor's bonds. No such materials and/or equipment, etc., shall be manufactured or delivered to the site, except at the Contractor's own risk, until the required samples/certificates/tests/etc., have been approved in writing by the Engineer. Any delay in the work caused by late or improper submission of the above for approval shall not be considered just cause for an extension of the Contract time.
- b. Samples. Unless otherwise specified, the Contractor shall furnish the required samples without charge, and shall provide every facility for the securing of material samples. He shall provide means and assist in the verification of all scales, measures and other devices which he operates. Samples to be submitted shall be taken by the Engineer or a laboratory approved by the Owner, unless otherwise specified. All materials being used shall be subject to re-sampling and testing at any time during their preparation and/or use. All samples submitted by the Contractor shall be properly identified to include, but not be limited to, the project name, project number, item number and description of material, name of the producer, place of origin, and other detailed information which will assist the Engineer passing upon the acceptability of the sample. Certified test reports, materials certificates and/or certificates of compliance required to be submitted with the samples or if permitted in lieu of samples, shall conform to the requirements stated hereafter.
- c. Certified Test Report. A certified test report shall be a document containing a list of the dimensional, chemical, metallurgical, electrical and physical results obtained from an actual test of the materials involved, and shall certify that the materials meet the requirements of the Contract Drawings and specifications, and shall also include the following information:
 - 1. Item number and description of material;
 - 2. Date of manufacture;
 - 3. Date of testing;
 - 4. Name or organization to whom the material is consigned;
 - 5. Quantity of material represented, such as batch, lot, group, etc.
 - 6. Means of identifying the consignment, such as label, marking, lot number, etc.
 - 7. Date and method of shipment;
 - 8. Name of organization performing tests.

The certified test report shall be signed by an authorized and responsible agent for the organization manufacturing the material, and it shall be notarized.

- d. **Materials Certificate.** A materials certificate shall be a document certifying that the materials, components and equipment furnished; conform to all requirements of the Contract Drawings and specifications. The document shall also include the following information:

1. Project to which the material is consigned.
2. Name of Contractor to whom material is supplies
3. Item number and description of material.
4. Quantity of material represented by the certificate.
5. Means of identifying the consignment, such as label, marking, lot numbers, etc.
6. Date and method of shipment.

The materials certificate shall be signed by an authorized and responsible agent for the organization supplying the material, and it shall be notarized.

- e. **Certificate of Compliance.** A certificate of compliance shall be a document certifying that the materials, components and equipment covered by the previously submitted certified test report and materials certificate, have been installed in the work and that conform to all the requirements of the Contract Drawings and specifications. The following information shall also be required on the document:

1. Project number;
2. Item number and description of material;
3. Quantity represented by the certificate;
4. Name of manufacturer.

The certificate of compliance shall be signed by an authorized and responsible agent for the prime Contractor, and shall be notarized.

- f. **Tests.** Tests as required by the Specifications will be made in accordance with the latest revision to the standard method in effect at the time of bidding of the American Society of Testing Materials, the New York State Department of Transportation, the American Water Works Association, the American Association of State Highway and Transportation Officials or any other organization that is recognized as an authority on a particular material unless otherwise specified on the Contract Drawings or Special Conditions. Representative preliminary samples of the material proposed for use shall be submitted, without charge, by the Contractor or producer for examination and tested in accordance with specified methods. All materials being used are subject to test or rejection at any time during their preparation and use Materials will be rejected by the Engineer whenever, in his judgment, they fail to meet the requirements of the specifications.

The Owner reserves the right to retest all materials which have been tested and accepted at the source of supply, after the same have been delivered, and to reject all materials which, when retested, do not meet the requirements of the specifications.

- g. Approval/Acceptance. Approval of any materials shall be general only and shall not constitute a waiver of the Owner's right to demand full compliance with Contract Requirements. After actual deliveries, the Engineer will have such check tests made as he deems necessary in each instance and may reject materials and equipment and accessories for cause, even though such materials and articles have been given general approval. If materials, equipment or accessories which fail to meet check tests have been incorporated in the work, the Engineer will have the right to cause their removal and replacement by proper materials or to demand and secure such reparation by the Contractor as is equitable.

The Engineer may accept a material or combination of materials and therefore waive non-complying test results provided that all of the following conditions are met:

1. Results of prior and subsequent series of tests of the material or materials from the same source or sources are found satisfactory.
2. The incidence and degree of nonconformance with the specification requirements are, in the Engineer's judgment within reasonable and practical limits.
3. The Contractor has diligently exercised material controls consistent with good practices in the Engineer's judgment.
4. No adverse effect on the value or serviceability of the completed work could result.

The Engineer may at his discretion waive testing of extremely minor quantities of material when such material is obtained from sources that are prevalently on test.

- h. Costs. Except as otherwise specifically stated in the Contract, the costs of sampling and testing will be divided as follows:

1. The Contractor shall furnish without extra cost, including packing and delivery charges, all samples required for testing purposes, including those samples taken on the project by the Engineer. The Owner shall pay all other testing costs of said samples.
2. The Contractor shall assume all costs of retesting materials which fail to meet Contract requirements.
3. The Contractor shall assume all costs of testing materials offered in substitution for those found deficient or for those specified.

122 MATERIALS AND WORKMANSHIP

- a. Unless otherwise specifically provided for in the Technical Specifications, all workmanship, equipment, materials and articles incorporated in the work shall be new and the best grade of the respective kinds for the purpose. Where equipment, materials, articles or workmanship are referred to in the Technical Specifications as "equal to" any particular standard, the Engineer shall decide the question of equality.
- b. All work performed and all materials furnished shall be, in conformity with the lines, grades, cross sections dimensions and material requirements, including tolerances shown on the Contract Drawings or indicated in the Specifications.
- c. The Contractor shall furnish to the Owner for approval the manufacturer's detailed specifications for all machinery, mechanical and other special equipment, which he

contemplates installing together with full information as to type, performance characteristics and all other pertinent information as required, and shall likewise submit for approval as required full information concerning all other materials or articles which he proposes to incorporate in the work. See Section - SAMPLES, CERTIFICATES AND TESTS.

- d. Machinery, mechanical and other equipment, materials or articles installed or used without such prior approval shall be at the risk of subsequent rejection.
- e. Materials specified by reference to the number or symbol of a specific standard, such as an ASTM Standard, a Federal Specification or other similar standard, shall comply with requirements in the latest revision thereof and any amendment or supplement thereto in effect on the date of the Invitation for Bids, except as limited to type, class or grade, or modified in such reference. The standards referred to, except as modified in the Technical Specifications, shall have full force and effect as though printed therein.
- f. The Contractor shall employ only competent and skillful men to do the work and whenever the Engineer shall notify the Contractor, in writing, that any man on the work is, in his opinion, incompetent or disorderly, the Contractor shall forthwith remove such person and shall not again employ him on any part of the work without the written consent of the Engineer.
- g. The Owner may stop any worker, any part of the work under the Contract if the methods or conditions are such that unsatisfactory work might result, if improper materials or workmanship is being used, or unsafe conditions exist. Any action by the Owner under this provision shall not be deemed a cause of delay and no extensions of permitted time will be granted because of such action.
- h. In the event the materials furnished or the work performed deviates from the requirements of the Contract Drawings and Specifications, but, in the opinion of the Owner, constitutes substantial performance, the Owner may accept the same. Should the deviation in question result in a savings to the Contractor the Owner will be entitled to a credit in the full amount of said savings. Should the deviation in question result in an additional cost to the Contractor, the Owner will not be liable to the Contractor for such additional cost.

If the materials or the finished product in which the materials are used or the work performed are not in conformity with the Contract Drawings and Specifications and have resulted in an inferior or unsatisfactory product, the work and materials shall be removed and replaced or otherwise corrected by and at the expense of the Contractor.

123 PERMITS AND CODES

- a. The Contractor shall give all notices required by and shall observe and comply with all Federal and State laws and Local by-laws, ordinances and regulations in any manner affecting the conduct of the work, and all such orders or decrees as may exist at present and those which may be enacted later, of bodies or tribunals having any jurisdiction or authority over the work. The Contractor shall indemnify and save harmless the Owner and Engineer and all of its officers, agents and servants against any claim or liability arising from or based on the violation of any such law, bylaw, ordinance, regulation, order or decree,

whether by himself or his employees. All construction, work and/or utility installations shall comply with all applicable ordinances and/or codes including any and all written waivers thereto.

Before commencing any work, the Contractor shall examine the Contract Drawings and Specifications for compliance with applicable ordinances, codes, etc. and shall immediately report any discrepancy to the Owner. Where the requirements of the Contract Drawings and Specifications fail to comply with such applicable ordinances, codes, etc. the Owner will adjust the Contract by Change Order to conform to such ordinances, codes, etc., (unless waivers in writing covering the differences have been granted by the governing body or department) and make appropriate adjustment in the Contract Price.

Should the Contractor fail to observe the foregoing provisions and proceed with the construction or work and/or install any utility at variance with any applicable ordinance, code, etc. , including any written waivers (notwithstanding the fact that such installation is in compliance with the Contract Drawings and Specifications), the Contractor shall remove such work without cost to the Owner, but a Change Order will be issued to cover only the excess cost the Contractor would have been entitled to receive if the change had been made before the Contractor commenced work on the items involved.

- b. Unless otherwise specified, the Contractor shall at his own expense, secure and pay to the appropriate department of the Local/State/Federal Government the fees or charges for all permits including but not limited to those required for the making of water taps and the supplying of any equipment required by the Regulations of the Consolidated Water District, Electrical Underwriters permits, and any other permits required by the regulatory body or any of its agencies.
- c. The Contractor shall comply with applicable Local/ State/Federal laws, ordinances, codes, etc. governing noise, the disposal of surplus excavation, materials, debris and rubbish on or off the Project Area and commit no trespass on any public or private property in any operation due to or connected with the work under this Contract.

124 CARE OF WORK

- a. The Contractor shall be responsible for the proper care and protection of all materials delivered and work performed until completion and final acceptance, whether or not the same has been covered in whole or in part by payments made by the Owner.

Materials shall be stored so as to insure the preservation of their quality and fitness for the work and shall be located so as to facilitate prompt inspection. When considered necessary, they shall be placed on wooden platforms or other hard, clean surfaces and not on the ground, and when directed, shall be placed in weatherproof buildings.

Stored materials, even though approved before storage, shall be inspected prior to their use in the work and shall meet the requirements of the specifications at the time it is proposed to use them.

- b. The Contractor shall at his sole expense and without any additional cost to the owner provide watchmen and/or other security measures as may be reasonably required to

properly protect and care for materials and work completed, and to otherwise prevent property damage and/or personal injury.

- c. In an emergency affecting the safety of life or property, including adjoining property, the Contractor, without special instructions or authorization from the Owner, is authorized to act at his discretion to prevent such threatened loss or injury, and he shall so act. He shall likewise act if instructed to do so by the Owner. Any compensation claimed by the Contractor on account of such emergency work will be reviewed by the Village Engineer to determine its validity. If compensation is determined to be valid then it will be determined by the Owner as provided in the Section - CHANGES IN THE WORK under GENERAL CONDITIONS.
- e. The Contractor shall avoid damage as a result of his operations to existing sidewalks, streets, curbs, pavements, utilities (except those which are to be replaced or removed), adjoining property, etc., and he shall at his own expense completely repair any damage thereto caused by his operations. If any damage is not repaired or acceptable arrangements for repair are not made within a reasonable period of time, the Village Administrator may act to repair such damage by Village forces or using another contractor employed for that purpose, and the costs of such repair shall be deducted from any payments due the Contractor. If a damage claim has been referred by the Contractor to his insurance company, such referral shall in no way relieve the Contractor of his responsibilities.
- f. The Contractor shall shore-up, brace, underpin, secure and protect as may be necessary, all foundations and other parts of existing structures adjacent to, adjoining, and in the vicinity of the site, which may be in any way affected by the excavations or other operation connected with the construction of this Contract. The Contractor shall be responsible for the giving of any and all required notices to any adjoining or adjacent property owner or other party before the commencement of any work. The Contractor shall indemnify and save harmless the Owner, the Village and the Engineer from any damages on account of settlements or the loss of lateral support or adjoining property and from all loss or expense and all damages for which the Owner, the Village and the Engineer may become liable in consequence of such injury or damage to the work or adjoining and adjacent structures and/or their premises.

125 ACCIDENT PREVENTION

- a. The Contractor shall exercise proper precautions and safety measures at all times for the protection of persons and/or property and shall be responsible for all injuries and/or damages to all persons and/or property, either on or off the site, which occur as a result of his prosecution of the work under this Contract. The safety provisions of all applicable Local/State/Federal laws and building and construction codes shall be observed and the Contractor shall take or cause to be taken such additional safety and health measures as the Owner may determine to be reasonably necessary.

Machinery equipment and trucks shall be properly guarded, and operational hazards shall be eliminated in accordance with the provisions and intent of the latest rules and regulations of OSHA, to the extent that such provisions are not in contravention of applicable law. The Contractor's attention is also called to the Section - SAFETY PROVISIONS of the GENERAL CONDITIONS.

- b. The Contractor shall maintain an accurate record of all cases of death occupational disease and injury requiring medical attention or causing loss of time from work arising out of and in the course of employment of the work under this Contract in accordance with the requirements of the applicable State/Local/ Federal regulations. The Contractor shall promptly furnish the Owner with reports concerning these matters.
- c. The Contractor shall indemnify and save harmless the Owner, Village and the Engineer from any and all claims for damages resulting from personal injury death and/or property damage suffered or alleged to have been suffered by any person as a result of any work conducted under this Contract. See also the Section INDEMNITY CLAUSE of the GENERAL CONDITIONS.

126 SANITARY FACILITIES

The Contractor shall furnish, install, and maintain ample sanitary facilities for the workmen. As the needs arise, a sufficient number of enclosed temporary toilets shall be conveniently placed as required by the Health/Sanitary Codes of the Local/State/Federal Government. Drinking water shall also be provided from an approved source so piped or transported as to keep it safe and fresh and served from single service containers or satisfactory types of sanitary drinking stands or fountains. All such facilities and services shall be furnished in strict accordance with existing and governing health/sanitary regulations.

127 USE OF PREMISES

- a. The Contractor shall confine his equipment, storage of materials, and construction operations to the Contract Limits as shown on the Drawings and as prescribed by ordinances or permits, or as may be desired by the Owner, and shall not unreasonably encumber the site or public rights of way with his materials and construction equipment.
- b. The Contractor shall comply with all instructions of the Owner, Engineer and the ordinances, codes, etc., of the Local/State/Federal Government, regarding signs, advertising, traffic, fires, explosives, danger signals, barricades, etc.

128 REMOVAL OF DEBRIS, CLEANING, ETC.

The Contractor shall, periodically or as directed during the progress of the work, remove and legally dispose of all surplus excavated material and debris, and keep the Project Area and public rights of way reasonably clear. Upon completion of the work, prior to final inspection, he shall remove all temporary construction facilities, debris and unused materials provided for the work, and restore the whole site of the work and public rights of way to a condition satisfactory to the Engineer. Trash burning on the site of the work will be subject to prior approval of the Owner and existing Local/State/Federal regulations.

The cost of all required clean-up shall be included in the various prices bid under this Contract.

129 LAYOUT OF WORK

The Contractor shall perform all layout work necessary for the satisfactory execution of the

construction as shown on the Contract Drawings and all costs in connection therewith shall be included in the contract price.

The Contractor shall employ competent personnel and all work shall be subject to the approval of the Engineer.

The Contractor shall be held responsible for the protecting and Safe guarding of all control points and bench marks set by the Engineer and his own forces. Any replacement or reestablishment of control points or bench marks by the Engineer, shall be at the expense of the Contractor. The required horizontal and vertical control necessary to perform this work is furnished on the Contract Drawings.

130 BLASTING

If explosives are used all requirements for transportation, use and storage of Local, State and Federal laws and regulations must be complied with and all necessary permits and licenses obtained by the Contractor at his expense. Permits and licenses must be shown to the Engineer on request.

Explosives must be carefully transported, stored, handled and used. The Contractor will keep on the job only such quantities of explosives as may be needed for the work underway and only during such time as they are being used. Explosives shall be stored in a secure manner in locked containers and separate from all tools. Caps and detonators shall be stored separately from other explosives. When the need for explosives is ended all such material remaining on the job shall be promptly removed from the premises. Care must be taken that no explosives, caps or detonators are stolen or get into the hands of unauthorized persons or left unguarded where they may cause accidents.

An accurate blasting log must be maintained continuously for the duration of the Contract. The log shall record, for each shot the location, number of holes, depth, spacing, amount of explosive per hole number of caps used and the exact date and time of the blast. In addition, a sketch showing displacement of direct and delay caps for each shot shall be recorded.

Explosives shall be such power and placed and used in such quantities and positions as will not make the excavation unduly large, nor shatter unnecessarily the rock upon or against which the main or structure is to be built, nor injure adjacent persons or property, those portions of the new work or structure as may already be in place or other adjacent pipes, ducts or other structures. The quantity of explosives fired at one blast must be small enough and the time for blasting selected to avoid undue annoyance to persons owning or occupying premises near the work.

The rock must be completely matted when blasts are fired to prevent damage or injury to persons or property or the scattering of broken fragments on the adjacent ground.

Adequate warning shall be given all persons in the vicinity before any blast is discharged.

When blasting is required, the operation shall be conducted with such care as not to cause damage to any of the existing underground utilities. Should such occur, the cost of repairs shall be the sole responsibility of the Contractor.

When blasting for trench excavation, each shot sequence shall begin sufficiently ahead of completed work to prevent damage to the completed work which must be properly protected prior

to each shot.

The provisions herein shall apply where soil formation resembles rock, whether in trench, structure or general excavation, even if it is of such a nature that it is not classified and paid for as rock excavation, and if ordered by the Engineer, will apply to openings cut through masonry, nested boulders or other materials not herein classed as rock.

In areas where the proposed construction is built against the face of rock excavation, all loosened or shattered portions of the rock must be completely removed by barring, wedging or other approved means so the masonry can be built firmly in contact with solid rock.

The Contractor shall notify each public utility or others having structures in proximity to the site, and others who may be affected, of his intention to use explosives. Said notice shall be given in accordance with the applicable regulations therefore and sufficiently in advance to enable the involved agencies/companies/persons and the Contractor to take such steps as may be necessary to protect life and property. Such notice shall not in any way relieve the Contractor of responsibility for any damage resulting from his blasting operations.

When in sufficiently close proximity to the existing gas, water, sanitary, storm, subway or other utilities and structures and all services connected thereto, the Contractor shall remove the rock by methods other than blasting, if necessary, and ordered by the Engineer in order to protect said utilities and their services from damage. Approved methods other than blasting are barring and wedging, jack hammer, drilling, rock jacks or other such hand or machinery methods which will not damage the adjacent utility. No explosives shall be brought into, stored or used on the site of any job by the Contractor unless and until he shall have furnished the Engineer with a satisfactory certificate of insurance showing that the risks arising from the presence of and use of explosives and from blasting are included within the insurance provided by the Contractor to secure his obligations to the Owner. Insurance should also cover damage to any underground utilities or other underground facilities.

131 INSPECTION/ACCEPTANCE OF THE WORK

All materials and workmanship shall be subject to inspection, examination or test by the Owner and the Engineer to determine the acceptability of the work at any and all times during manufacture or construction and at any and all places where such manufacture or construction is carried on and the Contractor shall provide proper facilities for such access and inspection. The Owner or Engineer shall have the right to reject defective material and workmanship or require its correction. The Owner or Engineer shall have the right to reject materials which have not been approved prior to incorporation in the work, and the right to reject work that has been performed without inspection. Rejected materials shall be removed and replaced without charge. Rejected workmanship shall be corrected, if possible, to the Engineer's satisfaction without additional charge. If in the opinion of the Engineer correction is not feasible, or if correction has been attempted but it not satisfactory to the Engineer, the work must be removed and replaced without additional charge. If the Contractor fails to proceed at once with the correction or replacement of rejected workmanship or defective material, the Owner may by contract or otherwise have the defects remedied or rejected materials removed from the Project Area and charge the cost of the same against any monies which are due or may become due the Contractor, without prejudice to any rights or remedies of the Owner.

Neither inspection, testing, approval nor acceptance of the work in whole or in part by the Owner or

its agents shall relieve the Contractor or his sureties of the full responsibility for materials furnished or work performed not in strict accordance with the Contract.

The assignment of a part time Inspector to this project will in no way relieve the Contractor of the requirement to comply with all of the specifications.

Where the Contractor has been directed by the Owner or Engineer to leave certain items of work exposed for inspection, and he fails to do so, he will be required to uncover such work at his own expense.

132 FINAL INSPECTION

When the improvements embraced in this Contract are substantially completed, the Contractor shall notify the Owner in writing that the work will be ready for final inspection on a definite date which shall be stated in the notice. The notice will be given at least ten (10) days prior to the date stated for final inspection, and bear the signed concurrence of the representative of the Owner having charge of inspection. If the Owner determines that the status of the improvements is as

represented, he will make the arrangements necessary to have final inspection commenced on the date stated in the notice, or as soon thereafter as is practicable.

The inspection party may also include the representative of the Federal Agency, other Governmental Agencies and representatives of each department of the Village having charge of improvements of like character when such improvements are later to be accepted by the Village.

133 INSURANCE

The insurance requirements for this contract are specified in Section E of these documents.

134 WARRANTY OF TITLE

No material, supplies or equipment, incorporated or to be incorporated in the work shall be purchased subject to any chattel mortgage or under a conditional sale or other agreement by which an interest therein or in any part thereof is retained by the seller or supplier. The Contractor shall warrant good title to all materials, supplies and equipment installed or incorporated in the work and upon completion of all work, shall deliver the same together with all improvements and appurtenances constructed or placed thereon by him to the Owner free from any claims, liens or charges. Neither the Contractor nor any person, firm or corporation furnishing any material or labor for any work covered by this Contract shall have any right to a lien upon any improvement or appurtenance thereon. Nothing contained in this paragraph, however, shall defeat or impair the right of person furnishing materials or labor to recover under any law permitting such persons was to look to funds due the Contractor in the hands of the Owner. The provisions of this paragraph shall be inserted in all subcontracts and material contracts and notice of its provisions shall be given to all persons furnishing material for the work when no formal contract is entered into for such materials.

135 GENERAL GUARANTEE

Neither the final certificate of payment nor any provision in the Contract nor partial or entire use of

the improvements embraced in this Contract by the Owner or the public shall constitute an acceptance of work not done in accordance with the Contract or relieve the Contractor of liability in respect to any express warranties or responsibility for faulty materials or workmanship. The Contractor shall promptly remedy any defects in the work and pay for any damage to other work resulting therefrom which shall appear within a period of one (1) year from the date of final payment. The Contract shall furnish a Maintenance Bond in the full amount of the Contract plus change orders to secure such guarantee. If any work is done under the guarantee and maintenance provisions, all contract provisions shall be reactivated. The guarantee and maintenance bond shall be extended with respect to such repair or replacement work for a period of one (1) year from the date the maintenance work was completed.

136 NO ARBITRATION

All claims, counterclaims, disputes and other matters in question between the Owner and the Contractor, not otherwise resolved, arising out of or relating to this agreement or its breach shall be decided in a court of competent jurisdiction. The Owner and the Contractor hereby agree that there shall be no requirement for arbitration of any controversies or disputes hereunder, all such matters to be resolved at law.

137 RISK OF LOSS

The Owner assumes no responsibility for the condition of existing buildings and structures and other property on the Project Area nor for their continuance in the condition existing at the time of issuance of the invitation for bids or thereafter. No adjustment of Contract Price or allowance for any change in conditions which may occur after the invitation for Bids has been issued will be made except as provided for herein.

138 REQUIRED PROVISIONS DEEMED INSERTED

Each and every provision of law and clause required by law to be inserted in this Contract shall be deemed to be inserted herein and the Contract shall be read and enforced as though it were included herein, and if through mistake or otherwise any such provision is not inserted, or is not correctly inserted, then upon the application of either party the Contract shall forthwith be physically amended to make such insertion or correction.

139 CORRECTIONS

The Engineer shall have the right to correct any errors or omissions in the Contract, specifications or Contract Drawings when such corrections are necessary for the proper expression of their intent.

Such corrections shall take effect from the time that the Engineer gives notice thereof, and any alterations in the work rendered necessary thereby shall be made as corrected. Any conflict between the approved Contract Drawings and specifications, or any disagreement in measurements upon the Contract Drawings must be submitted to the Engineer before construction of the work.

140 SAFETY PROVISIONS

The safety provisions of applicable laws, building and construction codes and the safety codes approved by the State Labor Commissioner shall be observed.

The provisions of the Federal Occupational Safety and Health Administration's "Occupational Safety and Health Standards" and "Safety and Health Regulations for Construction" shall be observed.

Should at any time during the work under this Contract any Local/State/Federal safety inspector visit the site for the purpose of a safety inspection, the Contractor shall immediately notify the Engineer's representative on the job site.

141 CONNECTING TO EXISTING WORK

The Contractor shall remove such existing masonry, concrete, equipment and piping as is necessary, in order to make the proper connections to the existing work at the locations shown. Also, he shall make the necessary pipe line, roadway and other connections at the several points in order that on completion of this Contract, water, sewage, or storm water as the case may be, will flow through the several pipe lines and structures. Unless otherwise specified herein, no extra payment will be made for this work, but the entire cost of the same shall be included in the unit or lump sum prices bid for the various items of the work to be done under this Contract.

142 EXISTING IMPROVEMENTS

The Contractor shall conduct his work so as to minimize damage to existing improvements, except where specifically stated otherwise in the specifications or drawings; it will be the responsibility of the Contractor to restore, as nearly as practical, to their original conditions all improvements on public or private property damaged by his operations.

The utility mains, ducts, poles and services in the construction area, where shown on the Contract Drawings are at the approximate locations furnished by various utilities concerned. Whenever existing improvement information is either indicated on the drawings or supplied to the Contractor at a later date, it is understood that such information is furnished in good faith for the Contractor's convenience. The Contractor must interpret this information according to his own judgment, and must make his own determinations regarding the location of all improvements. No claim will be allowed because of incorrect, incomplete or omitted existing improvement information.

The various utility companies have been made aware of the pending construction and are generally familiar with the locations of conflicts in the case of the proposed construction. The various utility companies will make all adjustments to their own lines except where otherwise shown on the Contract Drawings or specified. The Contractor shall give ample notice to the various utilities so that existing lines can be marked in the field and adjustments made. The Contractor shall cooperate fully with the various utilities and shall plan his work so that least interference is caused for all parties concerned. No additional payments shall be made to the Contractor for delays caused by utility interference. The Contractor shall support all utility lines uncovered during excavation.

143 ACCESS TO SITE

The Contractor shall make every effort to minimize damage to all access routes, and he shall be required to restore them to their original condition. The Contractor shall acquire all necessary permits for working in, on or from public streets or rights-of-way and for securing additional access rights thereto with respect to County and State Agencies. No Street Opening Permits will be

required by the Village but the ordinances and rules and regulations pertaining thereto are in full force and effect as if repeated herein.

All costs of the removal and restoration to original condition of walls, fences, structures, utility lines, poles, guy wires and anchors, and other improvements required for passage of the Contractor's equipment shall be borne by the Contractor. The Contractor shall notify the proper authorities of the Village and all utilities of any intended modification or disruption to their property prior to the start of construction and shall cooperate with them in the scheduling and performance of his operation.

If the Contractor, by direct negotiation and bargain with any land owner, leasee or tenant, has secured for himself any right to use more space or greater privileges than the space provided by the Owner for purposes incidental to the performance of the Contract, he shall, upon request of the Engineer, furnish to the Engineer proper evidence that such additional rights have been properly secured and assurance that no damage to or claim upon the Owner and/or Village will arise therefrom. The Owner and/or Village shall not be liable in any way for any expense incurred by the Contractor in securing any such right to use additional property.

The Contractor shall be responsible for and reimburse the Owner and/or Village and others for any and all losses, damage or expense which the Owner and/or Local Government or those others may suffer, either directly or indirectly or through any claims of any person or party, for any trespass outside the spaces and rights-of-way provided by the Owner to the Contractor or any violation or disregard of the terms and conditions established for the use or occupancy of those rights or for negligence in the exercise of those rights.

The Owner may retain or deduct from any sum or sums due or to become due to the Contractor such amount or amounts as may be proper to insure the Owner and/or Village against loss or expense by reason of the failure of the Contractor to observe the limits and conditions of the rights-of-way rights-of-access etc. provided by the Owner.

144 ACCESS TO ADJACENT PROPERTIES

The Contractor shall at all times maintain vehicular and pedestrian access to all properties abutting or adjacent to construction under this Contract, all at the Contractor's sole expense. In the event that normal access is cut off to a particular property due to operations or proposed work called for under this Contract, the Contractor shall, at his sole expense, make other arrangements for access to said property satisfactory to the property owner, tenant and the Engineer.

145 USE OF ROADWAYS

During the progress of the work, the Contractor shall make ample provision for both vehicular and foot traffic on any public road, and shall indemnify and save harmless the Owner from any expense whatsoever due to his operations on/over said roadways. The Contractor shall also provide free access to all fire hydrants, water and gas valves located along the line or in the vicinity of his work.

Gutters and waterways must be kept open or other provisions made for the removal of the storm water. Roadway intersections may be blocked but one-half at a time and the Contractor shall lay and maintain temporary driveways, bridges and crossing such as in the opinion of the Engineer, are necessary to reasonably accommodate the public and to provide access to private driveways. In the event of the Contractor's failure to comply with these provisions, the owner may cause the same to

be done, and will deduct the cost of such work from any monies due or to become due the Contractor under this Contract, but the performance of such work by the Owner or at its insistence shall serve in no way to release the Contractor from his general or particular liability for the safety of the public or the work.

146 INDEMNITY CLAUSE

The Contractor agrees to protect, defend, indemnify and hold the Village and its officers, employees, agents; the Engineer and his consultants; and New York State free and harmless from and against any and all losses, penalties, damages, settlements, costs, charges, professional fees or other expenses or liabilities of every kind and character arising out of or relating to any and all claims, liens, demands, obligations, actions, proceedings or causes of action of every kind and character in connection with or arising directly or indirectly out of this agreement and/or the performance hereof: without limiting the generality of the foregoing, any and all such claims, etc., relating to personal injury, death, damage to property, defects in materials or workmanship, actual or alleged infringement of any patent, trademark, copyright (or application for any thereof) or of any other tangible or intangible personal or property right, or any actual or alleged violation of any applicable statute, ordinance, administrative order, rule or regulation, or decree or any court shall be included in the indemnity hereunder. The Contractor further agrees to investigate, handle, respond to, provide defense for and defend any such claims etc. at his sole expense and agrees to bear all other costs and expenses related thereto, even if it (claims etc.) is groundless, false or fraudulent. In any case in which such indemnification would violate Section 5322.1 of the New York General Obligations Law, or any other applicable legal prohibition, the foregoing provisions concerning indemnification shall not be construed to indemnify the Village for damage arising out of bodily injury to persons or damage to property caused by or resulting from the sole negligence of the Village, or its employees.

147 DISPUTES

- a. All disputes arising between the parties arising out of, or in any way related to this Contract and/or the performance of the same, or its interpretation, shall within ten (10) days of the event or action giving rise to the dispute be presented to the Engineer. All papers pertaining to the dispute shall be filed in quadruplicate. Such notice shall state the facts surrounding the dispute in sufficient detail to identify the dispute together with its character and scope. In the meantime, the Contractor shall proceed with the work under this Contract as directed. Any dispute not presented within the time limit specified in this paragraph shall be deemed to have been waived, except that if the dispute is of a continuing character and notice of the dispute is not given within ten (10) days of its commencement, the dispute will be considered only for a period commencing ten (10) days prior to the receipt by the Engineer of notice thereof. The Contractor shall in no case allow any dispute to delay the work under this Contract.
- b. As soon as practicable after the final submission of all information the Owner shall make a determination of the dispute. Said decision of the Owner shall be a condition precedent to any further action on the dispute however, upon certification in writing by the claimant that the dispute has been submitted in its final form the Owner shall be obliged to render a decision on said dispute within sixty (60) days of the date of said certification. Should the Owner fail to render its decision within the aforementioned sixty (60) day period its

decision will not be a condition precedent to any further action on the part of the claimant.

- c. Each decision by the Owner will be in writing and will be mailed to the Contractor by registered or certified mail, return receipt requested, directed to this last known address.
- d. In the event of an unfavorable decision by the Owner the Contractor shall have the right to contest said decision as provided for under the provisions of this Contract. The Contractor shall in no case allow the dispute or decision to delay any work but shall notify the Owner promptly that he is proceeding with the work under protest and he say then except the matter in question from the final release.

148 GENERAL MUNICIPAL LAWS OF NEW YORK STATE

The attention of the Contractor is directed to the fact that all pertinent General Municipal Laws of the State of New York shall be adhered to. In addition, this contract is subject to all New York State statutes, including but not limited to the Village Law Highway Law, Real Property Law and Finance Law.

**149 “OR EQUAL” CLAUSE
UNLESS OTHERWISE SPECIFIED:**

Whenever a material, article or piece of equipment is identified on the Contract Drawings or in the specifications by reference to manufacturers’ or vendors’ names, trade names, catalogue numbers, etc., the intent is to establish a standard. Any material, article or equipment of other manufacturers and vendors of equally high quality (particularly with regard to points specified in the specifications) which will perform equivalently within the design ranges specified will be equally acceptable provided that the material, article or equipment so proposed is, in the opinion of the Engineer, of equal substance and function. Further the manufacturer must agree to comply fully with the warranty requirements of the specifications. The Contractor may not assume that substitute equipment will be approved by the Engineer and non-approval of said equipment will form no basis for a claim for additional compensation by the Contractor. No substitute equipment shall be purchased or installed by the Contractor without the Engineer’s written approval. If the Engineer’s approval is obtained for alternate equipment, the Contractor shall, at his own expense make any changes in the structures, building, piping or electrical necessary to accommodate the equipment and if engineering is required due to substitution of other material the Contractor shall reimburse the owner for the engineering service. The Contractor must pay for any laboratory testing required to establish the equality of his proposal.

150 CONSTRUCTION, EXCAVATION AND DEMOLITION OPERATIONS AT OR NEAR UNDERGROUND FACILITIES

The Contractor’s attention is directed to the State of New York, Department of Labor, Board of Standards and Appeals Industrial Code Rule 53 - “Construction, Excavation and Demolition Operations at or near Underground Facilities” effective April 1, 1975. The Contractor will be required to comply with all applicable requirements of Industrial Code Rule 53.

Requests for copies by mail should be directed to State of New York, Department of Labor, Office of Public Information, State Office Building Campus, Albany, New York 12201; or, single copies may be obtained by applying in person at the Department’s office in Albany or in New York City at

the Department of Labor, Two World Trade Center, New York, New York 10047.

151 REVIEW BY OWNER

The Owner, its authorized representatives and agents shall, at all times have access to and be permitted to observe and review all work, materials, equipment, payrolls, personnel records, employment conditions, material invoices and other relevant data and records pertaining to this Contract, provided, however, that all instructions and approval with respect to the work will be given to the Contractor only by the Owner through its authorized representatives or agents.

152 DEDUCTIONS FOR UNCORRECTED WORK

If the Owner deems it not expedient to require the Contractor to correct work not done in accordance with the Contract Documents, an equitable deduction from the Contract Price will be made by agreement between the Contractor and the Owner and subject to settlement, in case of dispute, as herein provided.

153 PATENTS

The Contractor shall hold and save the Owner and Engineer, their officers, and employees, harmless from liability of any nature or kind, including but not limited to court costs and attorney's fees, for or on account of, any patented or unpatented invention, process, article or appliance manufactured or used in the performance of the Contract, which has been recommended by the Contractor, including its use by the owner, unless otherwise specifically stipulated in the Technical Specifications.

154 INFORMATION FROM OWNER

In addition to showing the construction under this Contract, the drawings may show certain information obtained by the Owner regarding conditions and features which exist at the site of the work, both at and below the surface of the ground. The Owner and the Engineer expressly disclaim any responsibility for the accuracy or completeness of the information given on the drawings with regard to the existing conditions and features and the Contractor will not be entitled to any extra compensation on account of inaccuracy or incompleteness of such information. The information which is shown is only for the convenience of the Contractor, who must verify this information to his own satisfaction.

155 EXISTING UTILITIES, STRUCTURES AND FIXTURES

The Contractor will be required, at no additional expense to the Village, to do everything necessary to support, protect and sustain all sewer, water, gas mains or service pipes; electric light, power poles, telephone or telegraph poles, manholes, valve boxes, conduits and any and all utilities, structures or fixtures laid across or along the site of the work. In case any of the said utilities, structures or fixtures are damaged by the Contractor, they shall be repaired by the Contractor at his own expense, or by the authorities having control of the same and the expense of said repairs shall be deducted from the monies due or to become due the Contractor under this Contract.

Should it become necessary to remove or relocate any utilities, structures or other fixtures, due to a grade and alignment conflict which would require the proposed utility, structure or fixture (not

trench excavation, sheeting or other construction features) to occupy the same space as the existing pipe, pole, conduit and/or other fixture, the Contractor shall notify the owner of the obstruction and the Engineer of the location and the circumstances and shall cease work (which might prove detrimental to the utility, structure or fixture encountered) if necessary until satisfactory arrangements have been made with the owners of the same to properly care for and relocate them. Should it be necessary to cease work and a delay is caused thereby, the Contractor shall have no claim for damage or any claim other than for an extension of time. See GENERAL CONDITIONS, CLAIMS FOR EXTRA COST The removal or relocation of such interferences may be done by the owner of the interfering utility or structure with his own forces, or by a contractor whom he may engage for such purpose, or by private contract between the utility company and this contractor; or alternately he may request the Owner to cause this work to be performed under this contract (at the utility company's expense). In the last instance, the contractor shall perform such work under the terms of this contract and shall be compensated as described in GENERAL CONDITIONS - CHANGES IN THE WORK except where SPECIAL CONDITIONS or TECHNICAL SPECIFICATIONS provide otherwise.

If the Contractor desires temporary changes of location for his convenience for any reason whatsoever, of water lines, gas lines, sewer lines, wire lines, service connections, water and gas meter boxes, valve boxes, light standards, cableways, signals and any other utilities, structures or fixtures, he shall satisfy the Engineer and Owner that the proposed relocation does not interfere with his or other Contractor's operations, or the requirements of the Contract Drawings and does not cause an obstruction or a hazard to traffic. The Contractor shall make his own request to the utility company's pipe owners or other parties affected for such relocation work. Such relocation work for the convenience of the Contractor shall be made solely at the Contractor's expense.

The Contractor shall not remove or relocate any utility structure or fixture without the written approval of the owner of that utility, structure or fixture unless otherwise shown on the Contract Drawings, specifications or ordered by the Engineer.

156 CONTROL OF EXISTING FLOWS

During the construction of all proposed work, the Contractor shall take every precaution and do the necessary work to maintain the flow of storm drainage, sanitary sewage and natural flows through the working areas. The Contractor is solely responsible for providing his flow control system and there shall be no separate payment for the required work. The Contractor shall be responsible for any flooding or Sanitary backup on his work and to the property owners affected by such flooding or backup. The Contractor shall make such provisions as may be required by the local, state or federal health officers or any other public bodies with jurisdiction over the flow of storm drainage, sanitary seepage and natural flows.

In the event the Contractor uses water from natural water sources for his operations, intake method shall be such as to create no harmful effects; and where water is taken from a stream, reasonable flow downstream from the intake shall be maintained.

157 SEWAGE SURFACE GROUND WATER AND FLOOD FLOWS

The Contractor shall furnish all the necessary equipment, shall take all necessary precautions, and shall assume the entire cost of handling any sewage, seepage, storm, groundwater, surface and flood flows which may be encountered at any time during the construction of the work. The manner of

providing for these flows shall meet the approval of the Engineer and the entire cost of said work shall be included in the unit or lump sum prices bid for the various items of the work to be done under the Contract.

The Contractor shall employ such feasible and practical methods in his operations as will prevent pollution sedimentation or the introduction of impurities or other objectionable materials that may become suspended or dissolved in waters reaching streams, ponds, lakes, water supplies or other water bodies.

Water shall not be disposed of by discharging it into any street gutter, drainage channel, existing drainage system, natural stream, waterway, lake, pond or bog, etc. without the prior approval of the Authority having jurisdiction thereof. Should such approval be obtained the Contractor shall ensure that no solids, debris, suspended soil particles, impurities or pollutants are allowed to enter the drainage system. The Contractor shall be fully responsible for any damages to these systems resulting from his disposal methods and any necessary measures (such as but not limited to cleanup) required to return the system to preconstruction conditions. In addition to the above disposal, on private property shall be only with the prior written permission of the property owner.

Any water used for any purpose by the Contractor shall not be discharged in such a way as to create pollution, sedimentation or other adverse effects upon the aforementioned streams or waters.

In addition, the Contractor shall provide all necessary pumps, dams, drains, ditches, flumes, well points and other means of excluding and removing groundwater or water from any other source, from trenches, tunnels and other parts of the work and for preventing the trench slopes from sliding or caving. He shall sufficiently dewater all trenches, tunnels or other excavations to completely dry out and solidify the bottom of the trench to whatever depth is necessary below said bottom of the trench to provide a firm solid, completely dry bottom on which to place foundation material, lay pipe or build a structure.

It is expressly understood that the Engineer or Owner is not responsible for any flooding, high water tables, underground water or any other water problems which may be encountered on any portion of the work called for under this Contract and that the Contractor must include all anticipated costs for dewatering all excavations in the price bid under this Contract.

158 WEATHER CONDITIONS/WORK IN FREEZING WEATHER

In the event of temporary suspension of work, or during inclement weather, or whenever the Engineer shall direct the Contractor will, and will cause his Subcontractors to protect carefully his and their work and materials against damage or injury from the weather. If, in the opinion of the Engineer, any work or materials shall have been damaged or injured by reason of failure on the part of the Contractor or any of his Subcontractors so to protect his and their work, such materials shall be removed and replaced at the expense of the Contractor.

Unless written permission be given, work liable to be affected by frost or freezing shall be suspended during freezing weather. When work proceeds under such a condition the Contractor shall provide approved facilities for heating the materials and for protecting the finished work.

159 MAINTENANCE AND PROTECTION OF TRAFFIC

The provisions contained herein shall be deemed in effect unless more stringent provisions are called for within the Technical Specification. The Contractor will be required to protect and maintain pedestrian and vehicular traffic.

The Contractor shall maintain and protect traffic by so conducting his construction operations that the traveling public is subjected to a minimum of delay and hazard.

Residents along the existing roads and those having business along them shall have safe means of ingress and egress at all times. Traffic shall be maintained at the intersections of all roads or streets crossing the road construction. Where directed by the Chief of Police or the Contractor shall provide such adequate and proper bridges over excavations as may be necessary or directed for the purpose of accommodating pedestrians or vehicles.

In the event any portion of a public road must be closed to traffic, permission shall be secured by the Contractor from the Village Superintendent of Highways or County or State Highway Department if in their jurisdiction and notice must be given by the Contractor to the Police and Fire Departments, and adequate detour sign posted.

Approved signs shall be provided along all highways while work is in progress, and where traffic direction is required, flagmen shall be designated by the Contractor to direct traffic past the equipment, machinery or construction operations. Construction equipment shall be removed entirely from the traveled roadway when work is shut down for the day and two lanes of traffic shall be maintained at night. Barricades shall be placed wherever the safety of the traveling public requires, where a road is officially closed, where an excavation is being made, or where heavy construction equipment is operating. In addition, barricades shall be placed where they are deemed necessary in the opinion of the Chief of Police, to direct traffic or to prevent entrance to streets or areas where construction is in progress.

Barricades shall be in accordance with the Village Public Works Specifications and shall be lighted as provided therein. On traveled roads, a lighted warning sign is to be placed two-hundred (200) feet before the approach of barricades, or as is necessary for safety along the approach lines.

Where trenches have been cut, barricades, red flags, and warning signs, all properly lighted, shall be placed at frequent intervals and maintained until the trenches have been properly backfilled and compacted. All barricades, lights, flags, and bombs shall be maintained intact at all times overnight, over the weekends, holidays or if the project is shut down for any period of time.

160 HOURS OF WORK

No work shall be done on the job before 7:00 a.m. nor after 5:00 p.m. unless the Village is notified, nor shall any work be done on Saturdays, Sundays, or legal holidays unless Contractor shall have given Owner written request at least forty-eight (48) hours in advance. No additional payment will be made by Owner for overtime work under any circumstances unless a prior written order has been given by the Engineer. The Contractor shall comply with the Village Noise Ordinance which prohibits all work except emergency repair work, before 7:00 a.m. and after 8:00 p.m.

161 WATCHMEN

Contractor may, at his option and expense, employ watchmen to protect property at all times during which work is not under active supervision of his Construction Superintendent. Owner will not assume responsibility for losses or damage to property through theft or vandalism.

162 FIELD COPIES

The Contractor shall keep one copy of the specifications, plans and all shop drawings in good order, available to the Engineer and his representative at the job location.

163 EMERGENCY WORK

If in the opinion of the Village Administrator the work is carried on in such fashion that the public safety, private property, streets, or utilities are endangered, or that the work is carried on in such a manner as to create unnecessary inconvenience to the public, the Administrator shall, immediately upon giving notice, be authorized to undertake such corrective measures as he may deem to be necessary. The cost of such work shall be deducted from payments due the Contractor under this contract.

164 PROTECTION

The Contractor shall protect and maintain all property, structures and utilities, public or private and shall provide whatever means are required to do so, as part of this contract. The Contractor shall take steps to protect the site and neighborhood from dust, mud, paint, and inconvenience He shall take such steps as are necessary to prevent mud and silt from washing off the project area, prevent dust from blowing about the neighborhood, and prevent loaded trucks from spilling material upon traveled roadways. If the work is stopped for any purpose all rigging, scaffolds, and equipment shall be made secure to prevent any danger from wind, storm or accidents.

The Contractor must put up and maintain such barriers, signs and red lights as will effectively protect his work, materials, and prevent accidents in consequence of the work. Steps shall be taken to prevent trespass wherever the public may be endangered. He shall assume all liability occasioned in any way by his acts or neglect, or those of his agents, employees or workmen.

The Contractor shall so control his operation as to prevent damage to trees and shrubs which are to be preserved. Protection may include coverings, fences and boards lashed to trees to prevent damage from blasting or machine operations or hand tunneling through root areas. The Contractor shall carefully cut off all branches of trees which may have been broken or injured during construction. All tree repairs and painting of tree wounds shall be as specified in the New York State Department of Transportation Specifications.

Should work necessitate the moving of a survey monument the property owner, Village, County or other agency which can reasonably be assumed to have established the monument, shall be informed far enough in advance to arrange for adequate referencing. In no case, however, shall a monument be disturbed without prior approval of the Village Engineer.

All barricades, lights, flags, bombs and any other means ret up to protect the public or the work from injury or damage shall be maintained overnight, over week-ends and holidays, or for any

duration during which the job is not complete but the work may be shut down. Additional precaution such as filling of trenches or installation of steel plates may be required in areas of heavy traffic, on week-ends extended by legal holidays or when there is expectation of inclement weather.

165 PAYMENT FOR GENERAL CONDITIONS

The cost of the performance of any work required by these General Conditions shall be considered to be a part of the Contractor's Base Bid if the contract is a Lump Sum Contract, and spread out among all the unit prices if the contract is a Unit Price Contract There will be no additional payment for work required by these General Conditions.

166 DAMAGE TO PRIVATE PROPERTY

If the Contractor damages private property or facilities outside the designated work area (which work area is to be restored under the restoration provisions of the contract) he shall restore the private property or facilities promptly and completely in the same manner as specified under the restoration provisions of these specifications. If he does not do so within a reasonable period of time, as determined by the Village Administrator, the Owner may retain or deduct from any sum or sums due to the Contractor such amount or amounts as are necessary to correct the condition and employ Village forces or another contractor to do the corrective work. The fact that the Contractor has referred a damage claim to his insurance carrier shall not relieve him of liability for prompt and full restoration of damage. For purposes of this section of the contract, the Owner will treat what are essentially private facilities within a public right-of-way (including but not limited to mail boxes, shrubs, flowers and other plantings, walls, light poles, etc.) in the same manner as described above for private property.

167 RESTORATION

All man-made and natural features in the construction site disturbed or removed for the proper completion of the work shall be reset or replaced. All man-made or natural features damaged or destroyed shall be repaired or restored to a condition equal to or better than that existing at the start of the work, with materials equal to or better than the original ones.

In cases where it is impossible to replace an item with an equivalent item (large trees, exotic plants) the Contractor may, subject to the approval of the Engineer, substitute other similar items whose total value shall equal that of the destroyed one.

Where the work area extends onto private property, the Contractor shall make all reasonable attempts to satisfy the owners. In case of dispute, the Village Administrator shall be the judge as to the reasonableness of equivalency of repaired and restored features.

If the contract documents contain more detailed or more stringent specifications for restoration than in this section, the more detailed or stringent specifications shall take precedence over this section. If the contract documents do not contain detailed specifications for restoration, then this section expresses the intent of the Owner; all published specifications of the Owner containing details of construction applicable to items of restoration (e.g. grass, pavement, etc.) shall be deemed included in these contract documents as if set forth in full, if not actually printed herein.

All restoration work shall be maintained for a period of one year after the completion of the project

by this contract and secured by the maintenance bond.

If the contract documents contain a specific payment clause for restoration, then that clause shall apply; otherwise payment for restoration shall be as described in Section 165.

168. SITE VISITATION

Each bidder, before submitting any proposal for the work, shall visit the premises in order to familiarize himself with the conditions under which this work is to be done and with the obstacles to be overcome. The submission of any proposal shall be held as an acknowledgment that this requirement has been complied with. Contractor shall satisfy himself as to the nature and location of his work and the general and local conditions. He shall have full knowledge as to transportation, handling and storage of the materials, availability of electric power, and all other facilities in the area which will have a bearing on the performance of his work and the contract for which he submitted his proposal.

Lack of familiarity with the local conditions, due to failure to visit the site prior to the submission of proposal, will not be considered a valid excuse for any extras to the contract. Any failure by the Contractor to acquaint himself with all the available information shall not relieve him from any responsibility for performing his work properly.

No additional compensation will be allowed for conditions increasing the cost which were not known to or appreciated by him when submitting his proposal if the conditions were obvious and could have been discovered by him if he had visited the site and had thoroughly informed himself of all existing conditions which would affect his work.

SPECIAL CONDITIONS

201 **SCOPE OF WORK**

The contractor shall furnish all labor, materials, and equipment necessary for the milling and resurfacing of various streets and related work within the municipalities in accordance with the specifications and as directed by the Engineer or Superintendent.

202 **TIME OF COMPLETION**

The contractor shall provide the required bonds, insurances and other documents as required to complete this agreement within fifteen (15) business days (in the State of New York) of notice of award.

Work shall proceed as described herein. Once work has started, it shall proceed continuously and diligently. All curb installation shall be completed prior to paving for roads with both curbs and paving.

All work shall be completed by November 15, 2023.

203 **LIQUIDATED DAMAGES**

As actual damages for any delay in completion of the work, which the contractor is required to perform under this contract, are impossible of determination, the contractor and his sureties shall be liable for and shall pay to the owner the sum of Three Hundred Fifty Dollars (\$350.00) as fixed, agreed and liquidated damages for each calendar day of delay from the above stipulated completion, or as modified in accordance with the **GENERAL CONDITIONS**, until such work is satisfactorily completed and accepted.

204 **DELETION OF WORK**

The owner reserves the right to eliminate or reduce the scope of the work in any manner or way. There shall be no changes in the unit prices and the owner will not entertain any claims on account of reduction or deletion of work.

205 **TEMPERATURE CONDITIONS**

The owner WILL NOT, under any circumstances, waive the temperature restriction stated in Item 51A, Bituminous Top Course, concerning the placing of asphalt.

206 **SUPPLY OF WATER**

The contractor is responsible to supply his own water source that may be required to perform certain operations called for in this contract. At no time will the owner give permission to the contractor for use of the owner's water supply.

207 **ROAD CLOSING**

The contractor, at no time, will be granted permission to close any road to traffic. Traffic in each direction must be maintained at all times.

208 **MEASUREMENT OF TONNAGE**

Paving material delivered to the site shall be accompanied by certifications as to the weight and composition of the material from the plant operator as well as automated ticket printouts. No payment will be made for materials delivered but not incorporated in the work; and if partial loads are used, the trucks must be weighted on return for appropriate credit.

- 209 **TACK COAT**
Although a tack coat is called for under paving items, it shall be used only when placing new pavement on a pavement that is more than one month old or where pavement was milled.
- 210 **BLENDING TO EXISTING PAVEMENT AND AT CATCH BASINS**
The contractor is responsible to blend all new pavement with existing pavement on abutting and intersection streets and around all catch basins. This is to be achieved by cutting a key [one (1) foot wide minimum] to a depth of 1½” and/or as directed by the Engineer.
- 211 **ROADWAY REPAIR**
Upon completion of curb installation, the Contractor shall completely repair roadways disturbed in the curb trench with bituminous base and top courses. The area shall not be left as exposed subbase material or gravel.
- 212 **COORDINATION OF WORK**
The contractor shall schedule his work including familiarizing himself with the limits of proposed work with the Department of Public Works and the Police Department as to minimize the inconvenience of daily operations and traffic patterns.

Curbing Contractor shall coordinate work with Municipalities and Paving Contractor. All curbs shall be installed prior to roadway resurfacing for roads with both curbs and paving.
- 213 **DELIVERY OF HOT ASPHALT TRUCKS**
Each village reserves the right to weigh random asphalt trucks delivered to site prior to installation of pavement.
- 214 **TESTING OF MATERIAL**
Each village reserves the right to have samples of asphalt mix tested for conformance with New York State Department of Transportation (NYSDOT) specifications (Table 401-1).
- 215 **VEHICLES AND EQUIPMENT**
All Contractor or Subcontractor vehicles and equipment shall not display any imagery or wording beyond what is customarily necessary for identification and safety. If any imagery or wording is used that is not customarily necessary for identification and safety the contractor and his sureties shall be liable for liquidated damages for each calendar day until the imagery or wording is removed.
- 216 **JOINT SEALING**
All joints between new and existing pavement shall be sealed in accordance with the NYSDOT specifications and materials. The cost shall be included in asphalt top course and concrete curbs.
- 217 **HOURS OF WORK**
All construction work shall be performed in accordance with Part 160 “Hours of Work” of Section G “General Conditions” with the following exception: no work shall be performed before 8:00 a.m. on business days in the Village of Tarrytown.
- 218 **RIGHT-OF-WAY (ROW)**
Contractor shall identify items such as sprinklers, lighting, plantings, or other items in the ROW and bring them to the municipality’s attention prior to any excavation.

2023 CURB INSTALLATION AND REPLACEMENT CONTRACT

**Village of Ardsley
Village of Elmsford
Village of Hastings-on-Hudson
Village of Irvington
Village of Sleepy Hollow
Village of Tarrytown**

INDEX TO TECHNICAL SPECIFICATIONS

| <u>ITEM</u> | <u>DESCRIPTION</u> | <u>PAGE NUMBERS</u> |
|--------------------|---|----------------------------|
| 10A | Asphalt Miscellaneous Sidewalks, Swales & Driveways | 10A-1 – 10A-2 |
| 76 | Maintenance and Protection of Traffic | 76-1 – 76-2 |
| 97 | Concrete Curbs | 97-1 – 97-3 |
| 98P | Stone Paver Driveway Apron | 98P-1 – 98P-2 |
| 99 | Reinforced Concrete Sidewalks and Ramps | 99-1 – 99-5 |
| 102MHA | Adjusting Catch Basin and Manhole Covers | 102MHA-1 – 102MHA-3 |
| 127 | Restoration | 127-1 – 127-4 |

ITEM 10A - ASPHALT MISCELLANEOUS SIDEWALKS, SWALES & DRIVEWAYS

10A.1 WORK

- A. The Contractor shall furnish all labor, materials and equipment required to saw cut concrete and asphalt pavements, remove and dispose of pavements, completely install asphalt sidewalks, swales, and driveway apron areas as needed and as directed by the Engineer. The Contractor shall bring the subgrade to the required elevation, and place a subbase of four (4") inch thick crushed stone bed and install a two (2") inch thick asphaltic concrete sidewalk and pavements as shown and detailed on the plans or as directed by the Engineer. The Contractor shall bring the area behind or adjacent to the sidewalk, curb and paved areas to the required elevation and contour with topsoil if required and adjust utility structures in sidewalk areas to grade. This line item shall include handwork.
- B. The Contractor shall do all necessary cutting of roots, excavation and removal of all material of every nature and kind, preparing of subgrade and other incidentals required to complete the work in all respects. All pavements and surplus excavated material shall be hauled from the site of the work and legally disposed of as ordered by the Engineer.

10A.2 MATERIALS

- A. The two (2") inch (min. compacted depth) asphaltic top course Item No. 402.098104 shall conform to all materials and construction requirements for Bituminous Top Course Type F1 as specified in Table 401-1 "Composition of Hot Mix Asphalt Mixtures" of the most recent NYSDOT Standard Specifications.
- B. Tack coat shall be applied to all exposed edges that are to receive the top course. Tack coat shall be N.Y.S.D.O.T. Item 407.0102 – Diluted Tack Coat, material designation RS-1 (Table 702-9) or as approved by the Engineer.

10A.3 METHOD

- A. The Contractor shall remove and dispose of all existing asphalt and/or concrete, surface material, vegetation and excess earth within the proposed area. Unsatisfactory excavated foundation material shall be removed and replaced with clean suitable material.
- B. After the necessary excavation has been completed to the required subgrade and has been properly compacted to one hundred (100%) percent density, a layer of select granular fill shall be placed and compacted with an approved compactor to a compressed thickness of not less than four (4") inches or as shown on construction details.

- C. Asphalt shall be two (2") inches thick and laid to the elevations as needed or as directed in the field by the Engineer. The base shall be inspected by the Engineer prior to placing asphalt sidewalk. The asphalt sidewalk or driveway aprons shall be compacted with a minimum six (6) ton roller.

10A.4 MAINTENANCE AND PROTECTION OF EXISTING UTILITY STRUCTURES

- A. The Contractor shall adjust all existing utility structures to finished grade of new sidewalk pavement. Utility structures shall include, but not be limited to, manhole covers, valve boxes (water, gas and oil), and any other resetting within the new construction work as directed by the Engineer. The Contractor shall supply all labor, materials, and equipment necessary to adjust structures to finished grade. The Contractor shall incorporate the cost of these items in the bid price for their respective line items for valves, covers and frames.

10A.5 MEASUREMENT AND PAYMENT

- A. The quantity of material to be paid for under this item shall be the actual number of "SQUARE FEET" of asphalt top course constructed in accordance with the plans and specifications and directions of the Engineer. The Contractor shall only be paid for the construction of areas as dimensioned on the drawings and approved in the field by the Engineer. Measurements for payment shall be limited to and not exceed the pavement widths indicated on the plans.
- B. The unit price bid for this item shall be full payment for furnishing all labor, equipment and materials including saw cutting concrete and asphalt, removal and legal disposal of pavements and excavated material, the preparation, excavation and compaction of subgrade, furnishing and placing four (4") inch thick subbase material, installation of a two (2") inch thick bituminous pavement, removal and disposal of any surplus materials, and any other incidental work required for a complete asphalt sidewalk and driveway.

* * *

ITEM 76 -MAINTENANCE AND PROTECTION OF TRAFFIC

76.1. WORK INCLUDED:

- A. Under this item the Contractor will be required to protect and maintain pedestrian and vehicular traffic.

76.2. METHOD:

- A. The Contractor shall maintain and protect traffic by conducting his construction operations so that the traveling public is subjected to a minimum of delay and no hazard.
- B. Procedures to be followed are as outlined herein and as required under Section 619 of the New York State Department of Transportation Specifications, latest edition.
- C. Residents along the existing roads and those having business along them shall have safe means of ingress and egress at all times. Traffic shall be maintained at the intersections of all roads or streets crossing the construction. Where directed by the Owner, the Contractor shall provide adequate and proper bridges over excavations as may be necessary or directed for the purpose of accommodating pedestrians or vehicles.
- D. In the event any portion of a public road must be closed to traffic, permission shall be secured by the Contractor from the Engineer, and notice must be given by the Contractor to the Police and Fire Departments, and adequate detour signs posted.
- E. All approved construction signs must be posted prior to the interference, realignment, or obstruction of any lanes of traffic
- F. Approved signs in accordance with the New York State Manual of Uniform Traffic Control Devices shall be provided along all streets while work is in progress. Where traffic direction is required, flagmen shall be designated by the Contractor to direct traffic past the equipment, machinery or construction operations. Construction equipment shall be removed entirely from the traveled roadway when work is shut down for the day and normal lanes of traffic shall be restored. Barricades shall be placed wherever the safety of the traveling public requires them, where a road is officially closed, where an excavation is being made, or where heavy construction equipment is operating. In addition, barricades shall be placed where they are deemed necessary, in the opinion of the Engineer or the Chief of Police, to direct traffic or to prevent entrance to streets or areas where construction is in progress.
- G. All protruding rebar, bolts, rods, etc. must be protected from pedestrian and/or vehicular traffic. Protection Safety caps (i.e. Econo-Guard) must be installed on all exposed ends.
- H. Barricades shall be in accordance with the New York State Manual of Uniform Traffic Devices and shall be lighted as provided therein. On traveled roads, a lighted warning sign is to be placed two hundred (200) feet before the approach of barricades, or as is necessary

for safety along the approach line.

- I. Where trenches have been cut, barricades, red flags, and warning signs, all properly lighted, shall be placed at frequent intervals and maintained until the trenches have been properly backfilled and compacted.
- J. All barricades, lights, flags, and bombs shall be maintained intact at all times overnight, over the weekends, holidays or if the project is shut down for any period of time. This maintenance shall be included as part of the bid price for this item.
- K. Where steel plating over excavations is required, the plates shall be secured with sufficient spikes and blended into the existing pavement with either keyways or asphalt pavement. There shall be no exposed edges or corners of plates.
- L. If a NYSDOT permit is required for the work under this contract, the Contractor shall inform himself of all the rules, regulations and restrictions set forth by the NYSDOT permit concerning work within their right-of-way. If any of the Contractor's work is performed contrary to such laws, rules and regulations, he shall bear all resulting costs and fines.

76.3. PAYMENT:

- A. Payment for this work will be deemed included in all other items being bid and shall include the cost of furnishing all labor, materials and equipment necessary to erect, maintain and dismantle the required equipment.

* * *

ITEM 97 - CONCRETE CURBING

97.1. WORK:

- A. Under this item the Contractor shall excavate, backfill and supply all materials, labor, and equipment necessary to install concrete curbing and provide all necessary fill and topsoil and grass seed to restore the area as shown on plans.

97.2. MATERIALS:

- A. The material requirements, mix preparations and manufacturing of concrete shall comply with the specifications for Class A concrete in Section 501 – “Portland Cement Concrete – General” of the New York State Department of Transportation Standard Specifications.
- B. Concrete mix shall contain 20% Ground Granulated Blast Furnace Slag (GGBFS). The material requirements, mix preparations and manufacturing of using GGBFS as a partial replacement of concrete shall comply with the New York State Department of Transportation (NYSDOT) Standard Specifications Section 711-12 GROUND GRANULATED BLAST – FURNACE SLAG.
- C. Concrete shall contain an air entraining agent and shall have a strength of 4,000 lbs. per square inch at 28 days.
- D. Expansion material shall be one-half (1/2”) of an inch thick Premoulded Bituminous Joint Filler as specified in Section 705-07 of the NYS Department of Transportation Standard Specifications. Reinforcing bars shall be #5 bars - Item 709-01 (NYS Department of Transportation Specification). Curing and anti-spalling sealer shall be Durok Shield or equal.

97.3. METHOD:

- A. The Contractor shall excavate the curb trench to the proposed sub-grade. If such sub-grade is of unsuitable materials, all such materials shall be removed and replaced with select materials, as called for by the Engineer, tamped, and brought up to the proper grade.

97.4. CONSTRUCTION OF CURB:

- A. The Contractor shall construct a poured concrete curb with a width of six (6”) inches at the top, eight (8”) inches at the bottom, and a height of eighteen (18”) inches. The back of the curb shall be plumb, and the face shall be battered with the front edge bullnosed with three-quarter (3/4”) inch radius. All steel or wood forms shall be solidly braced, set accurately to line and grade and set up well in advance of a point to which concrete is being poured. The curb shall be set with a six (6”) inch reveal, or two (2”) inch reveal where depressed. The six (6”) reveal may vary from four (4”) inches to eight (8”), but requires that municipality be notified and the reveal approved prior to placement. The curb shall be finished in such a manner that the face is smooth and free of voids or depression. The Contractor shall set the required steel re-enforcing bar 2 inches from bottom of the curb. Expansion joints one-half (1/2”) inch in width shall be formed with Premoulded Bituminous Joint Filler and shall be placed every ten (10’) feet and where the ground changes in bearing character. The filler material shall be cut to conform to the cross section of the curb.

- B. Concrete shall not be poured until the Engineer has checked the forms to the proper lines and grades. Any variations exceeding one-quarter (1/4") inch in grade or one-half (1/2") inch in line shall be corrected. The Engineer shall also check the bracing of the forms, sub-grade conditions, and the proposed procedure of the pour. The Contractor shall provide such assistance as may be required in checking and shall be responsible for the proper shape, line and grade of the new curb.
- C. Except when given specific permission by the Engineer to do otherwise, concrete curb shall be poured only when the temperature is at least forty (40°F) degrees Fahrenheit and rising with no indication of falling to freezing until a safe set is obtained. During the cold months protection from freezing shall be available before the pour is begun.
- D. The forms shall be left in place until the concrete has set sufficiently so that, in the opinion of the Engineer they can be removed without injury to the curb. Concrete curb is to be finished in such manner that the face is smooth and free of voids or depressions, but no plastering will be permitted. For this work, competent and skillful finishers shall be employed.
- E. After finishing, the curb shall be protected from drying for at least three (3) days. At the time of acceptance, the entire curb must be free from any porous areas, cracks, chips and breaks, which may be considered objectionable by the Engineer.
- F. At the location of existing driveways or at locations ordered by the Engineer, drop curbs shall be formed in the freshly poured concrete for driveways.
- G. Driveway depressions shall be to a finished height of two (2") inches above finished pavement at the face of the curb, and shall slope upwards one (1") inch to the back of the curb. The front edge shall have a bullnose similar to, or of slightly greater radius than, the curb. The transition from the curb top to the depression shall be shaped as a smooth reverse curve in such a way as to allow safe passage for autos. Driveway depressions shall be in accordance with plans and as directed by the Engineer. They shall not be over twenty (20') feet without his specific permission.
- H. The newly laid curb shall be protected from traffic by barricades or other suitable methods until the concrete has properly set as judged by the Engineer.
- I. Two standard test cylinders are to be made with each pour, if directed by the Engineer, and cured under conditions equal to the curb.
- J. The area behind the curb shall be backfilled with topsoil and graded to blend with the existing grade. The existing blacktop behind the new curb shall be broken up and removed from the site and disposed of by the Contractor.
- K. All areas of asphalt disturbed by saw-cutting and curb installation shall be fully restored, including bituminous top and base courses. Contractor shall not leave the area as exposed subbase material or crushed gravel.

97.5. MEASUREMENT AND PAYMENT:

- A. Payment shall be made at the unit price bid (linear foot) for this item. Payment shall include all required saw cutting, excavation regardless of material, removal of the existing curb and asphalt pavement, furnishing and placing and removing forms, furnishing and placing

concrete at the proper line and grade, finishing, curing and protecting the curbs, backfilling and compacting the curbs and furnishing and installing joint material, and furnishing and installing rebar. Other work shall include full asphalt restoration including top and base courses, and any other work deemed included in the item by the Engineer.

* * *

ITEM 98P – STONE PAVER DRIVEWAY APRON

98P.1. WORK INCLUDED

- A. Under this item the Contractor shall furnish all labor, materials and equipment necessary to completely install cobble stone, slate, stone paver or similar driveway aprons, as well as concrete base and any other incidentals required as shown on the plans and as specified hereinafter. The joints shall be mortared cement grout, as shown on the plans, with joints not to exceed one-half (1/2") of an inch.

98P.2. MATERIALS

- A. Cobble stones, slates and pavers shall match existing materials to the greatest extent practicable.
- B. Cobble stone shall be new and shall be cut from fine to medium grained sound and durable granite. The granite shall be reasonably uniform in quality and texture throughout and shall be free from an excess of mica and feldspar and from seams, scales or evidence of disintegration. If used blocks are approved for reuse by the Engineer, they shall be clean, free of mortar, asphalt, and any other defects.
- C. The cobble stone shall be cut so that opposite faces will be approximately parallel and adjoining faces approximately at right angles to each other. Stone shall be so dressed that they may be laid with one-half (1/2") inch joints. All stone shall have a reasonably smooth, split head. Blocks shall be approximately 4" x 8" x 10" in dimension.
- D. The Contractor shall furnish two (2) samples of stones to the Engineer for approval before placing order or installing. Stones used on the work shall conform to the approved samples.

98P.3. METHOD

- A. The Contractor shall remove the existing driveway apron up to five (5') feet back from the edge of pavement for the installation of new curbs. The subgrade shall be compacted by a vibrating mechanical tamper or other approved method.
- B. If the subgrade is of unsuitable materials, all such materials shall be removed and replaced with select materials, as called for by the Engineer, tamped, and brought up to the proper grade. The removal of the unsuitable material and the replacement of select materials shall be included under this item for the first eighteen (18") inches of excavation as measured from existing grade.
- C. Backfilling shall be clean earth or other approved material, satisfactorily compacted.

98P.4. MEASUREMENT AND PAYMENT

- A. Under this item payment shall be measured in "SQURE FEET" of cobble stone, slate, or paver driveway aprons constructed in accordance with the plans, specifications and directions of the

Engineer.

- B. The unit price bid shall include the cost of furnishing, all labor, materials and equipment necessary to complete the work including but not limited to saw cutting asphalt and concrete, removal and disposal of removed and excavated materials, excavations, backfilling and tamping for providing and preparing cobble stone driveway aprons, mortar joints, and incidentals necessary to complete the work in accordance with the plans and specifications to the satisfaction of the Engineer.

* * *

ITEM 99 - REINFORCED CONCRETE SIDEWALKS AND RAMPS

99.1 WORK

- A. Under this item the Contractor shall furnish all labor, materials and equipment necessary to remove existing sidewalks throughout the project area and completely install the one-course air-entrained concrete sidewalks, vehicle and pedestrian ramps and subbase foundations in the thicknesses as specified herein. The Contractor shall remove existing sidewalks adjacent to the proposed sidewalk and existing sidewalks which require removal for the installation of the new sidewalks. The cost of the removal and disposal of all existing sidewalks shall be included in the unit price bid for new sidewalks.

- B. The price bid shall be a unit price per square foot of five (5") inch thick concrete with a six (6") inch subbase material for sidewalks and pedestrian ramps and seven (7") inch thick concrete with six (6") inch subbase material for vehicular ramps installed complete and shall include furnishing all labor, materials and equipment required. The Contractor shall do all necessary saw cutting of asphalt and concrete, removal and legal disposal of asphalt and concrete, preparing of subgrade, cutting of roots, excavation, adjust manhole covers, valves boxes, oil fills, existing utility structures, cellar doors and metal plates within sidewalk and ramp areas, replace existing roof and leader drains, providing, placing and tamping of subbase foundation, set forms, install expansion joints and wire mesh, provide and pour concrete, score and broom finish surface, remove forms, protect concrete, backfill sidewalk, apply sealing agent and any incidentals required to complete the work in all respects. All surplus excavated material shall be hauled from the site of the work and legally disposed or as ordered by the Engineer.

99.2 METHOD

- A. After the necessary excavations have been completed to the required subgrade and has been compacted to the satisfaction of the Engineer, a layer of select crushed stone shall be placed thereon and shall be compacted to a compressed thickness of not less than five (5") inches for sidewalks and pedestrian ramps and seven (7") inches for vehicular ramps.

99.3 FORMS

- A. Metal or wood forms shall be used in the construction of the sidewalks and ramp as required. The forms shall be set true to line and grade and shall be installed with sufficient bracing to prevent warping. Before any concrete is poured the Engineer shall approve the form work.

99.4 CONCRETE

- A. The concrete shall be poured in alternate panels and shall be evenly spread and leveled by screeding in such a manner as to obtain the required thickness and be poured in no more than twenty-five (25') foot strips to the width shown on the plans.
- B. The concrete shall consist of Class D Portland Cement, sand, crushed stone, water and admixture. All of the materials and concrete shall conform in every respect to the requirements contained in these Specifications and to the requirements set forth for "Rigid Pavement", Section 500 of the New York State Department of Transportation Specifications except that no gravel or slag will be used for coarse aggregate. A difference in the color of concrete used for a portion of the work shall be cause for the rejection of the sidewalk.
- C. Concrete mix shall contain 20% Ground Granulated Blast Furnace Slag (GGBFS). The material requirements, mix preparations and manufacturing of using GGBFS as a partial replacement of concrete shall comply with the New York State Department of Transportation (NYSDOT) Standard Specifications Section 711-12 GROUND GRANULATED BLAST – FURNACE SLAG.
- D. Concrete shall have a compressive strength of 4,000 psi and its slump shall be between two (2") and three (3") inches. The Concrete shall be proportioned in accordance with the aggregate weights specified for Class D concrete in New York State Department of Transportation Table 501-3.

99.5 REINFORCING MATERIALS

- A. Reinforcing materials shall be 6" x 6" 6 gauge (W2.9) welded wire fabric, (WWF): ASTM A185, welded steel wire fabric, as shown on the plans.

99.6 EXPANSION JOINTS

- A. A 3/8" X 5" approved premolded expansion joint shall be installed so that the top is 1/4" below the finish grade of the sidewalk, at intervals not greater than twenty-five (25') feet and also adjacent to all buildings, driveways, and other structures, and at such other locations as may be ordered by the Engineer. The premolded bituminous joint filler shall conform to requirements of ASTM D1751.

99.7 FINISH

- A. As soon as the concrete has set sufficiently to permit finishing operations, the surface of the concrete shall be rubbed with a wooden float. The "floating" shall remove all irregularities and produce a smooth and granular finish. The addition of cement to the surface will not be permitted. Unless otherwise directed as shown on the plans, the edges of each panel of segment shall be marked out with a standard edging tool having a radius of one-half (1/2") inch. The concrete walk surface shall be lightly broomed with a standard hair broom to produce a nonskid surface.

99.8 PROTECTION

- A. The Contractor shall apply a curing and protecting agent such as "Durok-Shield" manufactured by Durok or any approved equal. Application shall be in conformance with the manufacturer's instructions. Prior to any applications of the curing agent, the concrete surface shall be dry and cleaned of all dirt and debris. An admixture to achieve the same results may be added to the concrete mix.

99.9 MAINTENANCE AND PROTECTION OF EXISTING UTILITY STRUCTURES

- A. The Contractor shall adjust all existing utility structures to finished grade of new concrete pavement. Utility structures shall include, but not be limited to, manhole covers, valve boxes (water, gas and oil), coal chutes and other resetting within the new construction work as directed by the Engineer. The Contractor shall supply all labor, materials, and equipment necessary to adjust structures to finished grade as directed by the Engineer. The Contractor shall incorporate the cost of these items in the bid price for "Concrete Sidewalks".
- B. The price bid shall be a unit price per square foot of five (5") inch thick concrete with a six (6) inch subbase material for sidewalks and pedestrian ramps and seven (7") inch thick concrete with six (6") inch subbase material for vehicular ramps installed complete and shall include furnishing all labor, materials and equipment required. The Contractor shall do all necessary saw cutting of asphalt and concrete, removal and legal disposal of asphalt and concrete, preparing of subgrade, cutting of roots, excavation, adjust manhole covers, valves boxes, oil fills, existing utility structures, cellar doors and metal plates within sidewalk and ramp areas, replace existing roof and leader drains, providing, placing and tamping of subbase foundation, set forms, install expansion joints and wire mesh, provide and pour concrete, score and broom finish surface, remove forms, protect concrete, backfill sidewalk, apply sealing agent and any incidentals required to complete the work in all respects. All surplus excavated material shall be hauled from the site of the work and legally disposed or as ordered by the Engineer.

99.10 OTHER REQUIREMENTS

- A. The Contractor shall construct Sidewalk Pedestrian and Vehicular Ramps as shown on the plans or as directed by the Engineer.
- B. The Contractor shall reconstruct existing roof drains and underside walk drains located within the areas of new concrete sidewalks. The method and materials for reconstruction or replacement of existing drainage facilities shall be determined by the Engineer and shall be in accordance with the details of the contract documents and in conformance with these specifications.
- C. The Contractor will be required to install an approved sealant between new sidewalk and existing buildings. This sealant shall be a two component polysulfied polymer base material meeting or exceeding Federal Specification TT-S-0027, Type II such as "DAP Two-Part Flexiseal" as manufactured by DAP, Inc. of Dayton, Ohio or approved equal. Color shall be as selected by the Engineer.

- D. This sealant shall be used in conjunction with a suitable primer. This primer shall be a synthetic resin solution compounded specifically for promoting adhesion to the substrate involved with as DAP Flexiseal Primer or approved equal. Backup material shall be untarred oakum fiberglass, polyurethane foam or polyethylene foam. No oily or asphaltic type materials shall be used. A bond breaker such as polyethylene film must be used between filler and sealant. The fill shall be uniform to provide minimum sealant depth of three (3") inches.
- E. The Contractor will be required to remove any sealant for other compounds that discolor the sidewalk. Any sidewalk permanently stained by sealant or other compounds will be removed and replaced at the Contractor's expense.
- F. The Contractor shall include in his bid price any labor, materials and equipment required to maintain in proper order at all times, all private and public utility pipes, line and services and service boxes within his work area; and any damaged article shall be promptly replaced at the Contractor's expense to the satisfaction of the Engineer.
- G. The Contractor shall not leave the concrete wet and susceptible to marks by passersby, and must provide adequate protection to discourage this. Concrete marked in anyway will not be accepted by the Town and will be the responsibility of the Contractor to be re-poured as directed by the Engineer.
- H. The Contractor shall verify location of existing utilities whether underground or overhead and shall maintain in proper operating condition these utilities. If temporary utility services are required, the Contractor shall see to it that it is provided and it shall be his responsibility to maintain such temporary facilities unless they are specifically to be maintained by others by prior written agreement.

99.11 MEASUREMENT AND PAYMENT

- A. The quantity of concrete to be paid for under this item shall be the actual number of "SQUARE FEET" of concrete sidewalks, pedestrian ramps and vehicular ramps constructed in accordance with the plans and specifications and directions of the Engineer. The bid price shall be per square foot of concrete and subbase in place complete. The Contractor shall saw cut and remove existing sidewalks adjacent to the proposed sidewalk and existing sidewalks which require removal for the installation of the new sidewalks. The cost of the removal and disposal of all existing sidewalks shall be included in the unit price bid for new sidewalks.
- B. The price bid shall be a unit price per square foot of five (5") inch thick concrete with a six (6) inch subbase material for sidewalks and pedestrian ramps and seven (7") inch thick concrete with six (6") inch subbase material for vehicular ramps installed complete and shall include furnishing all labor, materials and equipment required. The Contractor shall do all necessary saw cutting of asphalt and concrete, removal and legal disposal of asphalt and concrete, preparing of subgrade, cutting of roots, excavation, adjust manhole covers, valves boxes, oil fills, existing utility structures, cellar doors and metal plates within sidewalk and ramp areas, replace existing roof and leader drains, providing, placing and tamping of subbase foundation, set forms, install expansion joints and wire mesh, provide and pour concrete, score and broom finish surface, remove forms, protect concrete, backfill

sidewalk, apply sealing agent and any incidentals required to complete the work in all respects. All surplus excavated material shall be hauled from the site of the work and legally disposed or as ordered by the Engineer.

ITEM 102MHA -ADJUSTING CATCH BASINS AND MANHOLE COVERS

102MHA.1. WORK INCLUDED:

- A. Under this item, catch basin grates and manhole covers and frames shall be adjusted to finished grade of new pavement. This item also includes rebuilding of catch basins or manholes where directed.

102MHA.2. PROCEDURE:

- A. The Contractor shall determine the elevation of finished pavement grade and shall set the rim of the grate or cover one-quarter (1/4") inch below said finished grade. The pavement and any subgrade material shall be carefully and neatly excavated around the frame to the elevation of the bottom of the frame. The pavement shall be cut by means of a pneumatic drill with a spade-shaped bit or other means to provide a neat, even edge.
- B. The frame shall be lifted out and a ring of mortar, or brick and mortar, shall be placed on the top of the structure and below the casting so as to raise it. The outside of the ring shall extend at least as far as the outer edge of the flange of the casting. The inside of the ring shall not extend any further than the inside wall of the structure block or brick, and shall not obstruct the opening in any way. If the required thickness of the ring to bring the frame to the proper elevation is greater than the thickness of a brick, the ring shall be constructed of bricks with mortar joints and with a leveling course of mortar. If the required ring thickness is less than one brick, the entire ring shall be of mortar. The mortar shall be allowed to harden thoroughly before traffic or rollers are permitted to pass over the frame. Wooden wedges will not be permitted.
- C. After the frame has been set to grade, the excavated space shall be filled with a sandy or gravelly material free of clay, organic material or large stones and topped with six (6") inches of asphalt binder course material so as to be flush with the adjoining existing pavement. This material shall be thoroughly tamped to a density equal to that of the adjoining material. Before placing this material, the casting shall be primed with a liquid asphalt so as to provide a tack coat.
- D. Where directed by the Owner or Engineer, the contractor shall rebuild the walls of the manhole or catch basin using solid concrete bricks and mortar to match the size of the existing basin. Existing walls shall be demolished to the depth indicated and rebuilt. Contractor shall be responsible for disposal of all demolition materials, and backfill and restoration of the area surrounding the manhole or catch basin. Interior surface of the brick shall be parged where required to match the existing surfaces. Precast concrete structures may be used where approved by the Engineer. Invert and sump elevations shall be measured in the field. Shop drawings for precast structures shall be submitted to the Engineer for review prior to ordering or installing.

E. MORTAR FOR MANHOLES

1. Mortar for plastering manholes and drainage structures shall be made of one part Portland cement and two parts fine aggregate.

F. BRICK AND BLOCK

1. Brick for brick and mortar structures shall conform to the current ASTM Specification C32. Block for block and mortar structures shall conform to the current ASTM Specification C135.
2. The concrete block masonry used to construct manhole and catch basin walls shall be solid curved blocks with the inside and outside surfaces curved to the required radii. The blocks shall have tongue and groove or other approved type of joint at the ends so that the units interlock to form a strong, rigid structure. Curved blocks shall have the inside and outside surfaces parallel.
3. The block shall not exceed 18 inches in length or 8 inches in depth (height). No block shall be less than 6 inches in width (thickness). All blocks in one structure shall be of the same height dimension. The blocks shall be designed for length so that only full-length or half-length blocks are required to lay the circular wall of any one course.
4. Blocks intended for use in the cones or tops of manholes and catch basins shall have such shape as may be required to form the structure as shown on the Plans with inside and outside joint not to exceed 1/4-inch in thickness.

G. CASTINGS

1. The Contractor shall furnish and install all cast iron catch basin frames and grates conforming to the details indicated on the drawings and as specified. Sizes and dimensions of steel castings shall be field verified.
2. The castings shall be of good quality, strong, tough, even grained cast iron, smooth, free from scale, lumps, blisters, sandholes, and defects, of every nature which would render them unfit for the service which they are intended. Contact surfaces of grates and frame seats shall be machined to prevent rocking of grates. Materials shall comply with materials listed on the New York State Department of Transportation (NYSDOT) approved list of materials or as approved by the Engineer.
3. All castings shall be thoroughly cleaned and subject to a careful hammer inspection. Castings shall be at least Class 25 conforming to the ASTM A48 "Standard Specifications for Gray Iron Castings".
4. Prior to castings being shipped from the foundry, shop drawings shall be submitted to the Engineer for written approval. Castings shall be given one coat of coal-tar pitch varnish, applied in a satisfactory manner so as to make a smooth coating, tough, tenacious, and not brittle nor with any tendency to scale off.
5. Unless otherwise specified or indicated on the drawings, castings in paved areas

shall be capable of withstanding H-20 loading and shall meet the requirements of the municipality in which they are installed.

102MHA.3. MEASUREMENT AND PAYMENT:

- A. Under Item 102MHA-1, payment shall be for each frame and grate cover structure adjusted to grade and shall include all labor, materials and equipment for the saw cutting excavation, mortar or brick and mortar ring, resetting of casting, backfill with paving material and any other construction described above. The insertion of metal rings or adapters such as Rite-Height, Adjusted to Grade or similar will not be accepted as a substitution for the above. A new frame and grate cover structure will be required when noted on bid sheet.
- B. Under Item 102MHA-2 payment for each structure reconstructed or replaced up to 2 feet deep from finished grade and adjusted to grade shall include all labor, materials and equipment for the saw cutting excavation, removal and disposal of material to be replaced, brick and mortar walls, resetting of casting, backfill with paving material and any other construction described above. A new frame and grate cover structure will be required when noted on bid sheet.
- C. Under Item 102MHA-3 payment for each structure completely reconstructed or replaced shall include all labor, materials and equipment for the saw cutting excavation, removal and disposal of existing structure, brick and mortar walls, replacement of casting, backfill with paving material and any other construction described above.

* * *

ITEM 127 – RESTORATION

127.1. WORK INCLUDED:

- A. Under this item the Contractor shall provide all the labor, materials, and equipment necessary to restore the site to its original condition All man-made and natural features in the construction site disturbed or removed for the proper completion of the work shall be reset or replaced. All manmade or natural features damaged or destroyed shall be repaired or restored to a condition equal to or better than that existing at the start of the work, with materials equal to or better than the original ones.
- B. Physical features damaged outside the limits of the work, as determined by the Engineer, shall be repaired as described in the “General Conditions.”
- C. Restoration of utility lines of private companies or municipalities is covered under the General Conditions and is not included as part of this item.

127.2. PROCEDURE:

- A. After the new work in an area has been completed tested and accepted, or when ordered by the Engineer, the restoration of all the man-made and natural features disturbed shall proceed.
- B. These features are of the general types outlined below but not necessarily limited to these specific items, as this specification item covers all required restoration work within general categories:
 - 1. TREES, shrubbery and bushes.
 - 2. GARDENS (Rock gardens, flowers annual, perennials, etc.) with all soils and mulches.
 - 3. GROUND COVERS (Pachysandra, myrtle, phlox, ivy, etc.) with all soils and mulches.
 - 4. LAWNS (Fescues, bluegrasses, perennial ryes, zoysia, etc.) with all topsoils or sod. See paragraph "Grass Areas" below.
 - 5. WALLS and wall footings (stone, masonry, brick, dry bound etc.)
 - 6. GUIDE RAILING & FENCES (Chain link, picket, board, barbed wire, “W” Beam, Box Beam). This shall include such new work as footings, posts, guys or braces as may be required to secure the work.
 - 7. SIDEWALKS, PATHWAYS, PATIOS (Concrete, flagstone, crushed stone, precast slab, brick, gravel, slate, terrazzo, tile).
 - 8. CURBS and curb footings (Concrete, asphalt, granite, stone brick, metal, etc.)

9. DRIVEWAYS (Concrete, slab, gravel, crushed stone and asphalt).
10. PRIVATE UNDERGROUND UTILITIES (Footing drains, roof leader drain, dry wells, private electric cables, sprinkler system, swimming pool appurtenances, septic fields, etc.)
11. FRONT OR REAR YARD MAN-MADE FEATURES (Mail boxes, sign posts, lamp posts, dog houses, bird baths, pigeon coops, storage sheds, fireplaces, barbecue pits, trash burning pits, playing courts, religious crèches, awnings, gates, wells, etc.) can best be handled if they are carefully removed and replaced after the construction. Those disturbed, damaged, or destroyed shall be reset, repaired, or replaced.

C. Equivalent Items

1. All features damaged or destroyed shall be repaired or restored with features equal to or better than the original ones. The Contractor shall make all reasonable attempts to satisfy the owner of the features but the Owner shall be the judge as to the reasonableness of equivalency of repaired and restored features.
2. In cases where it is impossible to replace an item with an equivalent item (large trees, exotic plants) the Contractor may substitute other similar item whose total value shall equal that of the destroyed one. This shall be done to the satisfaction of the owner of the item. In such cases the Contractor shall secure a written release from the homeowner stating that he is accepting a substitute for the destroyed item and that he releases the Contractor and the Owner from further claims for said item. The Superintendent of Public Works shall be the judge of the value of the destroyed and the value of the restored items and the reasonableness of the substitution.

D. Grass Areas

1. Immediately after backfilling, grass areas shall be temporarily restored using fast germinating annual or perennial rye grass seed. The patched area shall be watered as necessary to insure proper germination.
2. All disturbed grass areas shall be permanently replaced during the planting seasons from April 7th to May 15th and from August 25th to October 1st as follows:
 - (a) Harrow the ground.
 - (b) Remove weeds and other undesirable growth.
 - (c) Furnish and place a minimum of four (4") inches of screened topsoil obtained from a local nursery.
 - (d) Rake and grade topsoil to match adjoining area; the Engineer is to approve the grading before fertilizing and seeding.
 - (e) Furnish and place 15 lb. of fertilizer containing by percentage of weight: Kentucky Bluegrass 50%, Red Top 5%, Pennlawn Fescues 25%, Creeping Red Fescues 20%, to every 1,000 square feet of area. If this specific mixture is unavailable, the Contractor shall request permission to utilize a specific comparable mixture.
 - (f) The Contractor shall water the newly planted grass until the grass reaches

- a stand of four (4") inches.
- (g) The Contractor shall be responsible for restored grass areas until final acceptance by the Owner. He shall regrade, reseed, refertilize, etc., any grass that has failed to maintain a dense stand or any area that has lost its grade due to settlement of the trench. The finished restored area shall be free of weeds and shall have the same density of grass as the adjoining areas.
 - (h) In lawn areas that contain Zoysia grasses the Contractor shall replace the area with the same.
3. In lieu of the above method of placing topsoil and seeding, the Contractor may substitute sodding, at his own option and at no extra cost to the Owner.

E. Protection of Trees

- 1. The Contractor is advised that the construction has been located to avoid tree clusters and individual mature trees. In constructing the contract work, the Contractor shall coordinate construction activities in the vicinity of street trees with the Owner. The trunks are to be protected with heavy wooden fences. All trees in the vicinity of construction activity are to be secured in a manner acceptable to the Engineer to prevent toppling. The Contractor shall avoid cutting more than one-third (1/3) of a tree root system, as measured by the perimeter of the canopy. The Contractor shall avoid cutting roots greater than one inch in diameter. Under low canopy trees the Contractor shall modify the vertical extension of the construction equipment boom to avoid injury to the low tree branches. Construction equipment movement in the vicinity of trees shall be kept to a minimum to avoid compaction of the soil around the trunks of trees. During backfill operations the Contractor shall avoid excessive tamping of earth around the roots and trunks, and shall apply an approved mulch to the roots during the operation.

F. Maintenance

- 1. All work done as part of this item shall be maintained for a period of one year after the completion of the project by this contract and secured by the maintenance bond.
- 2. Trenches that have settled shall be refilled to the proper grade. If this refilling operation disturbs the previous restoration of lawns etc., the lawns, etc., shall again be restored to their original condition under this item and at no additional cost to the Owner.
- 3. Items replaced replanted or restored shall be protected to insure their proper establishment. This protection may take any form required such as guying, wrapping, covering, barricades, shoring, etc.

G. Re-grading Surfaces to Finished Grade

- 1. In some instances, grading by machines will not be considered as properly or

APPENDIX A

SUMMARY OF QUANTITIES - CURB INSTALLATION AND REPLACEMENT CONTRACT 2023
VILLAGE OF ARDSLEY - VILLAGE OF ELMSFORD - VILLAGE OF HASTINGS-ON-HUDSON
VILLAGE OF IRVINGTON -VILLAGE OF SLEEPY HOLLOW
VILLAGE OF TARRYTOWN

| Spec. Sec. | Bid Item | Units | Ardsley | Elmsford | Hastings-On-Hudson | Irvington | Sleepy Hollow | Tarrytown | Total |
|--|--|-------|---------|----------|--------------------|-----------|---------------|-----------|---------------|
| 10A | Asphalt Miscellaneous Sidewalks, Swales, and Driveways | SF | 1,590 | 0 | 1,550 | 0 | 0 | 100 | 3,240 |
| 76 | Maintenance and Protection of Traffic | NP | NP | NP | NP | NP | NP | NP | NP |
| 97 | Concrete Curb (with GGBFS) | LF | 4,015 | 1,400 | 3,994 | 0 | 0 | 3,000 | 12,409 |
| 98P | Stone Paver Driveway Apron | SF | 180 | 50 | 600 | 0 | 0 | 0 | 830 |
| 99 | Concrete Sidewalks and Ramps (5") | SF | 170 | 0 | 660 | 0 | 0 | 400 | 1,230 |
| 99 | Concrete Sidewalks and Ramps (7") | SF | 0 | 0 | 350 | 0 | 0 | 0 | 350 |
| 102MHA-1 | Catch Basin Frames and Grates - Adjustment | EA | 0 | 2 | 11 | 0 | 0 | 0 | 13 |
| 102MHA-2 | Catch Basin Frames and Grates - Replacement | EA | 0 | 0 | 0 | 0 | 0 | 0 | 0 |
| 127 | Restoration | NP | NP | NP | NP | NP | NP | NP | NP |
| The contractor is further advised that the estimated quantities shown in the Bid Sheets may be reduced or deleted in order to insure that this Contract can be completed within the budget established for this work. In the event that certain work is deleted or reduced, the Unit Price Bid shall remain in effect for this work. | | | | | | | | | |

APPENDIX B

LEGEND

— PROP. CURBS LOCATION

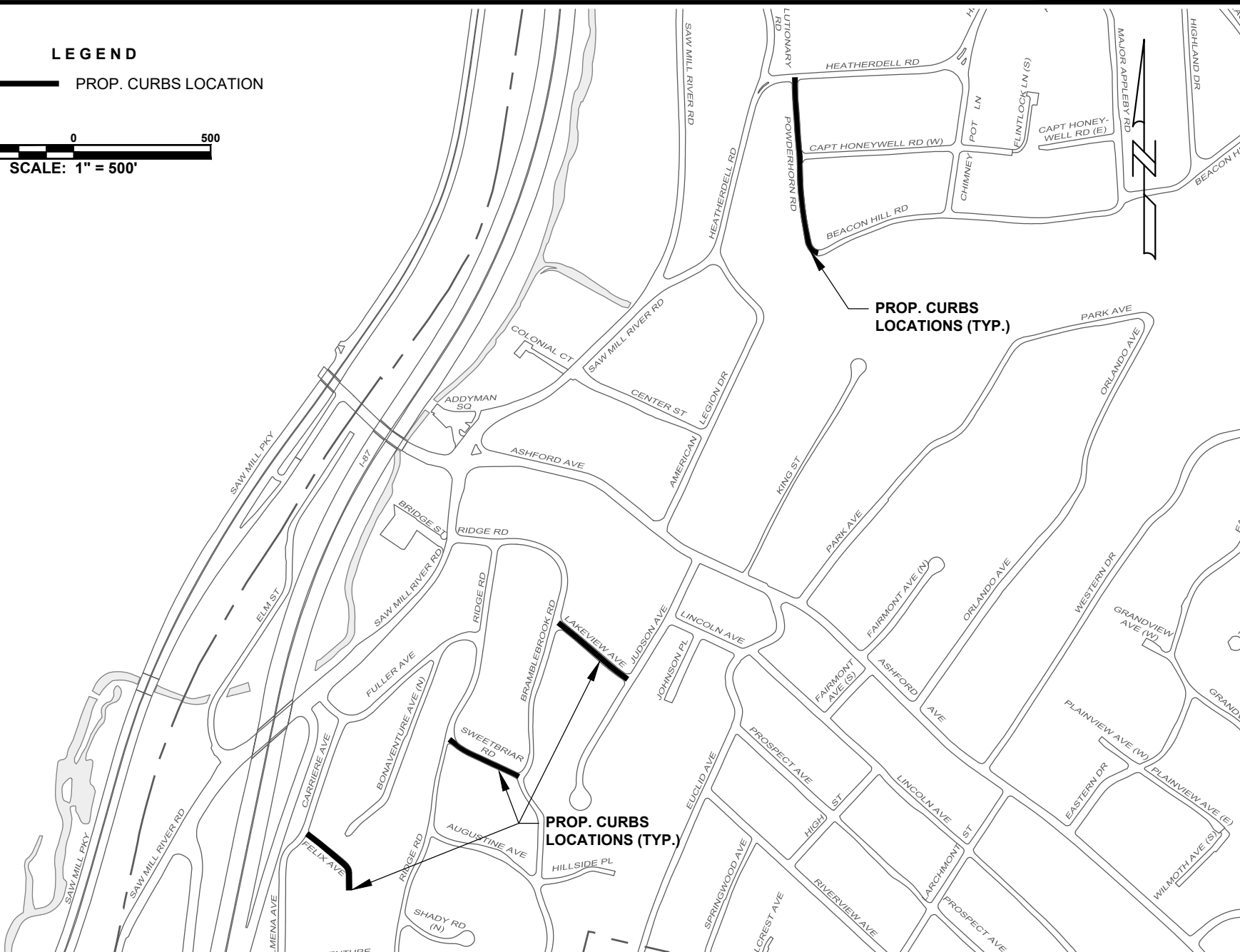
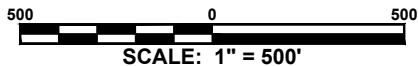

H:\Ardsley\ Village Maps\Road Improvements\Road Improvements-Year 5.dwg | 3/31/2023 8:48:25 AM

| JAMES J. HAHN ENGINEERING, P.C. Putnam Business Park 1689 Route 22 Brewster, New York 10509 Tel: (845) 279-2220 | | | TITLE | SCALE | DATE | | | | | | |
|---|---------|---------|---|------------|---------------|---|---------|---------|---------|-------------|-----------|
| | | | CURBS LOCATION PLAN | 1" = 500' | 3/15/23 | | | | | | |
| <table border="1"> <thead> <tr> <th>REV.</th> <th>DATE</th> <th>DESCRIPTION</th> </tr> </thead> <tbody> <tr> <td>1</td> <td>3/30/23</td> <td>VILLAGE</td> </tr> </tbody> </table> | | | REV. | DATE | DESCRIPTION | 1 | 3/30/23 | VILLAGE | PROJECT | DRAWING NO. | SHEET NO. |
| | | | REV. | DATE | DESCRIPTION | | | | | | |
| 1 | 3/30/23 | VILLAGE | | | | | | | | | |
| | | | PROPOSED VILLAGE OF ARDSLEY 2023 CURB IMPROVEMENTS VILLAGE OF ARDSLEY, WESTCHESTER COUNTY, NY | C-1 | 1 OF 1 | | | | | | |

**SUMMARY OF QUANTITIES - CURB INSTALLATION AND REPLACEMENT CONTRACT 2023
VILLAGE OF ELMSFORD**

| Spec. Sec. | Bid Item | Units | Chester Avenue Hartsdale Road to Fairmont Street (end) |
|---|--|--------------|---|
| 10A | Asphalt Miscellaneous Sidewalks, Swales, and Driveways | SF | 0 |
| 76 | Maintenance and Protection of Traffic | NP | NP |
| 97 | Concrete Curb (with GGBFS) | LF | 1,400 |
| 98P | Stone Paver Driveway Apron | SF | 50 |
| 99 | Concrete Sidewalks and Ramps (5") | SF | 0 |
| 99 | Concrete Sidewalks and Ramps (7") | SF | 0 |
| 102MHA-1 | Catch Basin Frames and Grates - Adjustment | EA | 2 |
| 102MHA-2 | Catch Basin Frames and Grates - Replacement | EA | 0 |
| 127 | Restoration | NP | NP |
| <p>The contractor is further advised that the estimated quantities shown in the Bid Sheets may be reduced or deleted in order to insure that this Contract can be completed within the budget established for this work. In the event that certain work is deleted or reduced, the Unit Price Bid shall remain in effect for this work.</p> | | | |

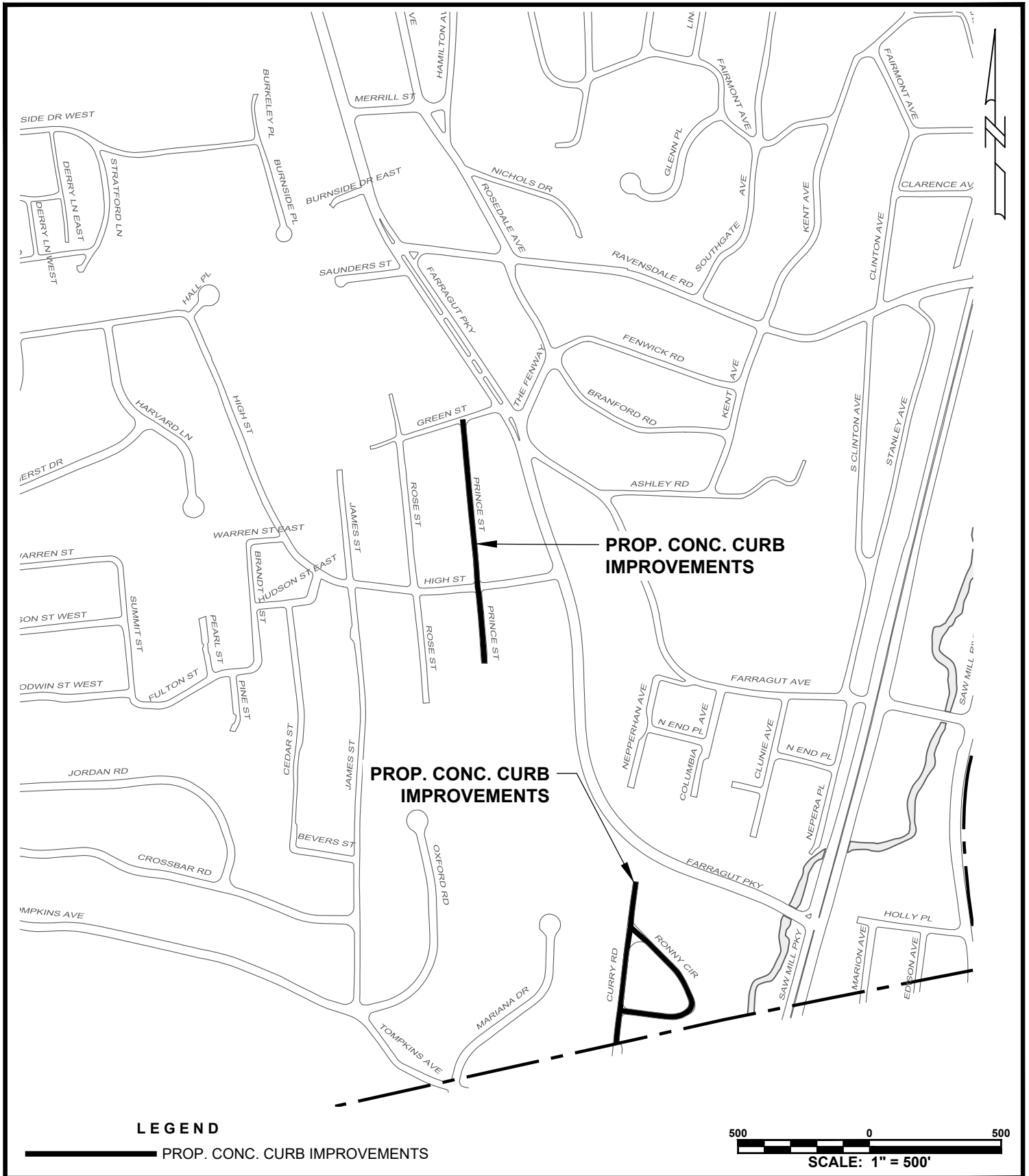

| | | | | |
|---|-------------|--------------------|--|----------------------------|
| LEGEND | | | SCALE: 1" = 500' | |
| PROP. CONC. CURB IMPROVEMENTS | | | | |
| | | | TITLE CURB IMPROVEMENTS LOCATION PLAN | |
| | | | PROJECT VILLAGE OF HASTINGS-ON-HUDSON 2023 CURB IMPROVEMENTS | |
| REV. | DATE | DESCRIPTION | | |
| JAMES J. HAHN ENGINEERING, P.C. | | | Putnam Business Park 1689 Route 22 Brewster, New York 10509 Tel: (845) 279-2220 | |
| | | | SCALE 1" = 500' | DATE 03/27/23 |
| | | | DRAWING NO. C-1 | SHEET NO. 1 OF 1 |

**SUMMARY OF QUANTITIES - CURB INSTALLATION AND REPLACEMENT CONTRACT 2023
VILLAGE OF TARRYTOWN**

| Spec. Sec. | Bid Item | Units | Total |
|---|--|--------------|--------------|
| 10A | Asphalt Miscellaneous Sidewalks, Swales, and Driveways | SF | 100 |
| 76 | Maintenance and Protection of Traffic | NP | NP |
| 97 | Concrete Curb (with GGBFS) | LF | 3,000 |
| 98P | Stone Paver Driveway Apron | SF | 0 |
| 99 | Concrete Sidewalks and Ramps (5") | SF | 400 |
| 99 | Concrete Sidewalks and Ramps (7") | SF | 0 |
| 102MHA-1 | Catch Basin Frames and Grates - Adjustment | EA | 0 |
| 102MHA-2 | Catch Basin Frames and Grates - Replacement | EA | 0 |
| 127 | Restoration | NP | NP |
| <p>The contractor is further advised that the estimated quantities shown in the Bid Sheets may be reduced or deleted in order to insure that this Contract can be completed within the budget established for this work. In the event that certain work is deleted or reduced, the Unit Price Bid shall remain in effect for this work.</p> | | | |

APPENDIX C

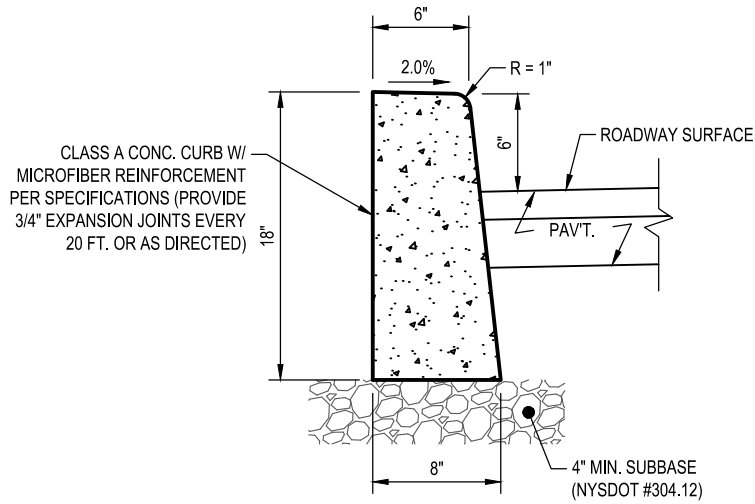

SECTION

NOTE: EXPOSED CURB SURFACES TO RECEIVE TWO COATS OF SEALER PER SPECIFICATIONS.

CONCRETE CURB

N.T.S.

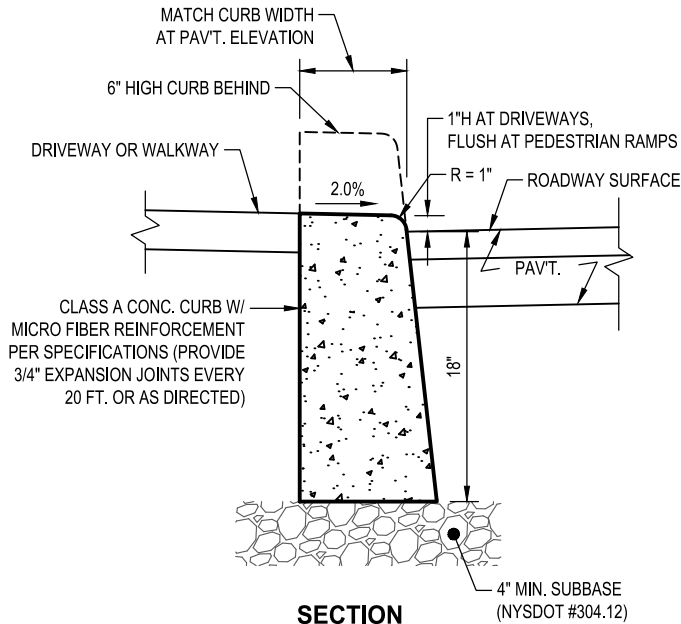

SECTION

NOTE: EXPOSED CURB SURFACES TO RECEIVE TWO COATS OF SEALER PER SPECIFICATIONS.

CONCRETE DROP CURB

N.T.S.

H:\Haslings-on-Hudson\109029-Roadway Improvements 2023\details\details-109023.dwg | 4/12/2023 8:48:08 AM

| | | | | |
|------|------|-------------|---------|---|
| | | | TITLE | DETAILS (SHEET 1) |
| | | | PROJECT | 2023 CURB INSTALLATION & REPLACEMENT CONTRACT |
| REV. | DATE | DESCRIPTION | | |

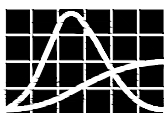

JAMES J. HAHN
ENGINEERING, P.C.

Putnam Business Park
1689 Route 22
Brewster, New York 10509
Tel: (845) 279-2220

| | | | |
|-------------|----------|-----------|---------|
| SCALE | AS NOTED | DATE | 3/31/22 |
| DRAWING NO. | D-1 | SHEET NO. | 1 OF 4 |

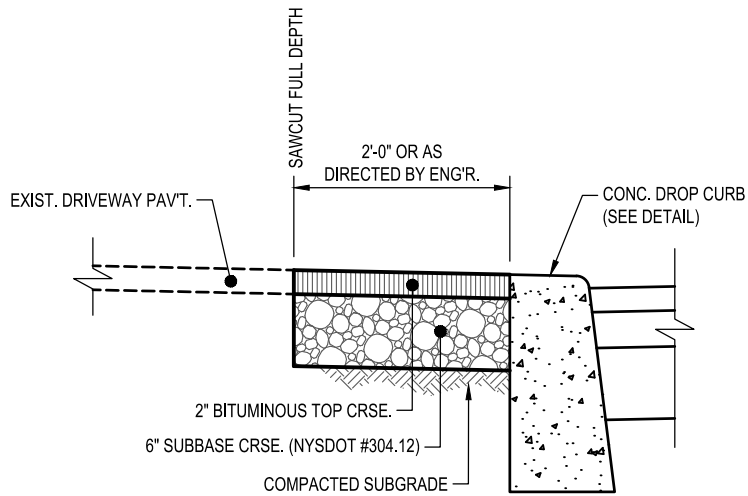

SECTION

ASPHALT DRIVEWAY REPLACEMENT

N.T.S.

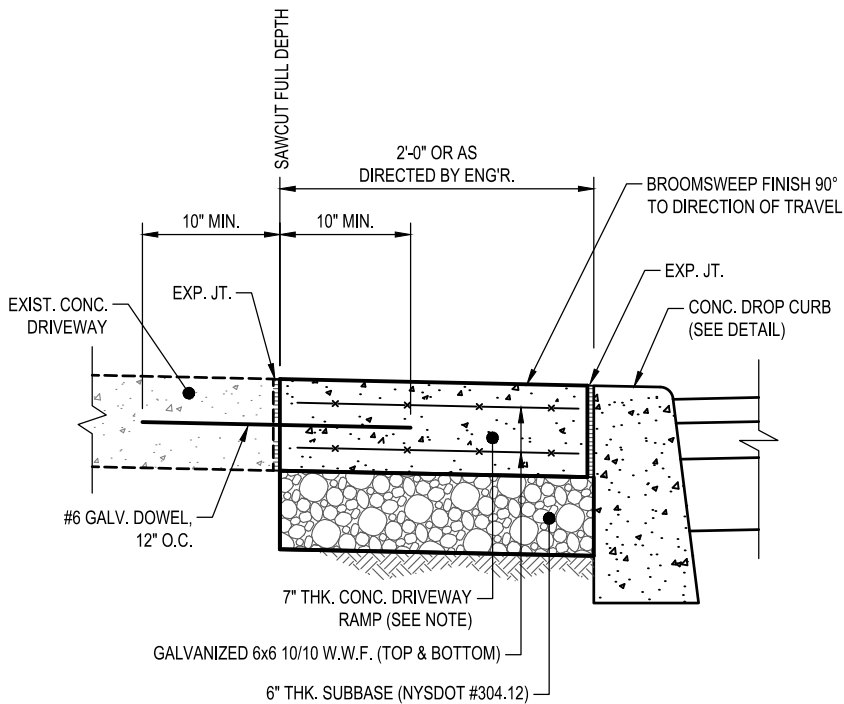

NOTE:
PROVIDE SCORE JOINTS AT 5' MAX. O.C. AND CONSTRUCTION JOINTS AT 20' MAX. O.C.

SECTION

CONCRETE DRIVEWAY REPLACEMENT

N.T.S.

TITLE

DETAILS (SHEET 2)

PROJECT

2023 CURB INSTALLATION & REPLACEMENT CONTRACT

| REV. | DATE | DESCRIPTION |
|------|------|-------------|
| | | |
| | | |
| | | |

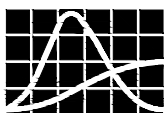

JAMES J. HAHN
ENGINEERING, P.C.

Putnam Business Park
1689 Route 22
Brewster, New York 10509
Tel: (845) 279-2220

SCALE
AS NOTED

DATE
3/31/22

DRAWING NO.

D-2

SHEET NO.

2 OF **4**

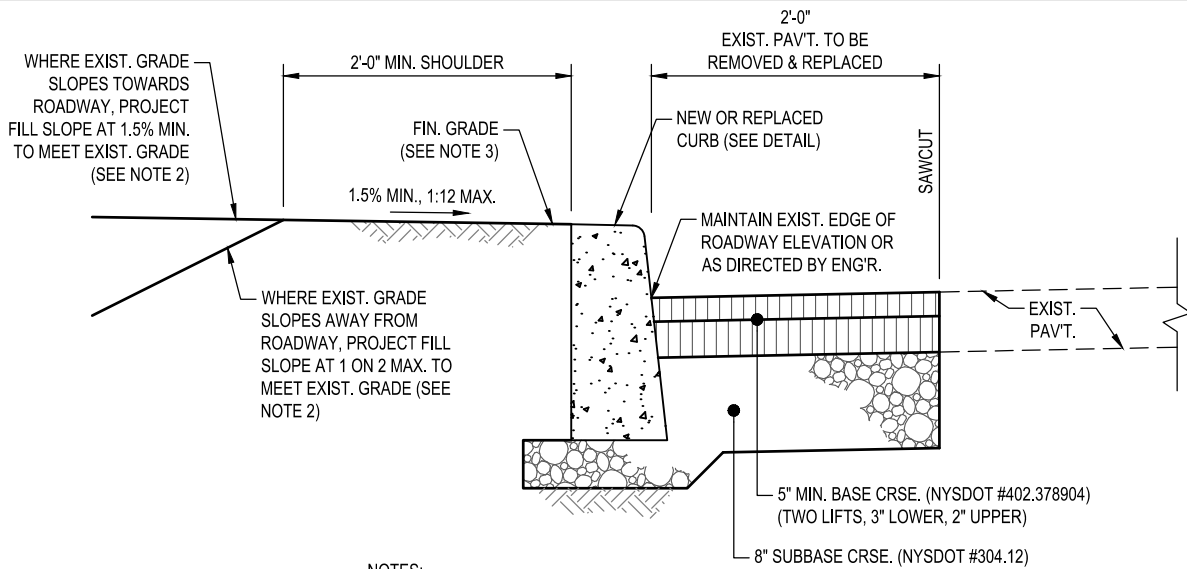

NOTES:

1. TACK COAT EXISTING SURFACES PRIOR TO PLACEMENT OF NEW ASPHALTIC COURSES.
2. FILL BEHIND NEW CURB SHALL BE SLOPED TO ALLOW FOR POSITIVE DRAINAGE WITHOUT THE FORMATION OF LOW SPOTS.
3. FILL BEHIND NEW CURB TO INCLUDE 4" MINIMUM THICKNESS OF TOPSOIL.

SECTION

PAVEMENT RESTORATION & SHOULDER AT NEW CURB

N.T.S.

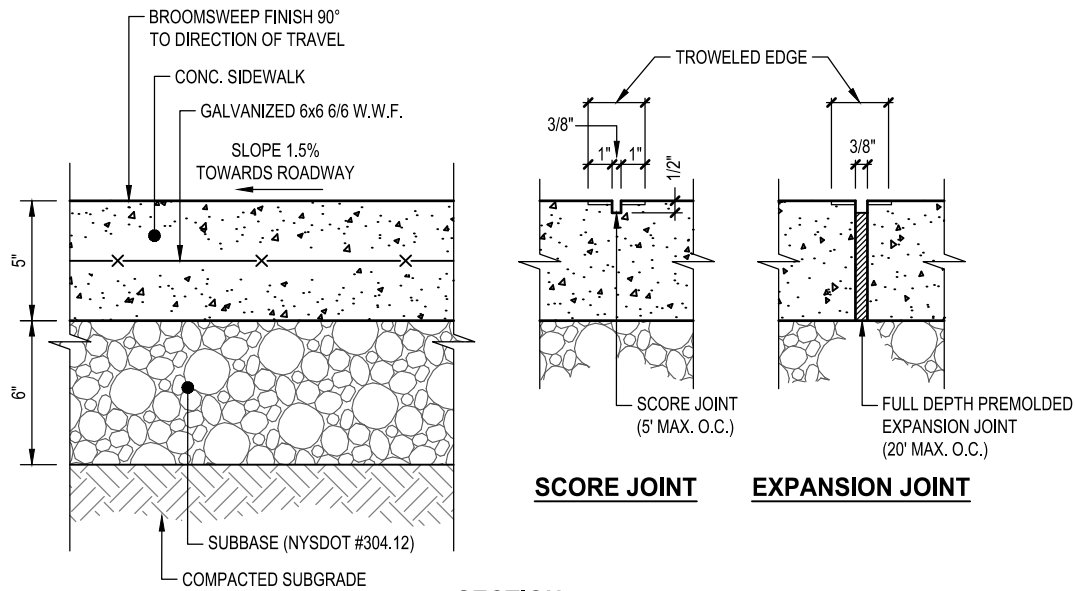

SECTION

CONCRETE SIDEWALK

N.T.S.

| | | | | | |
|------|------|-------------|---------|--|--|
| | | | TITLE | DETAILS (SHEET 3) | |
| | | | PROJECT | 2023 CURB INSTALLATION & REPLACEMENT CONTRACT | |
| REV. | DATE | DESCRIPTION | | | |

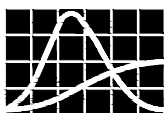

JAMES J. HAHN
ENGINEERING, P.C.

Putnam Business Park
1689 Route 22
Brewster, New York 10509
Tel: (845) 279-2220

| | | | |
|-------------|----------|-----------|---------|
| SCALE | AS NOTED | DATE | 3/31/22 |
| DRAWING NO. | D-3 | SHEET NO. | 3 OF 4 |

NOTES:

- EXISTING STONE PAVERS SHALL BE CLEANED OF OLD MORTAR AND SHALL BE REUSED IF POSSIBLE. ANY NEW PAVERS SHALL MATCH THE EXISTING PAVERS.
- CONTRACTOR SHALL MATCH THE CONDITIONS OF EXISTING PAVING AND BEDDING SECTION IF DIFFERENT FROM THAT SHOW HEREON.
- PAVER PATTERN SHALL MATCH THE EXISTING PATTERN.

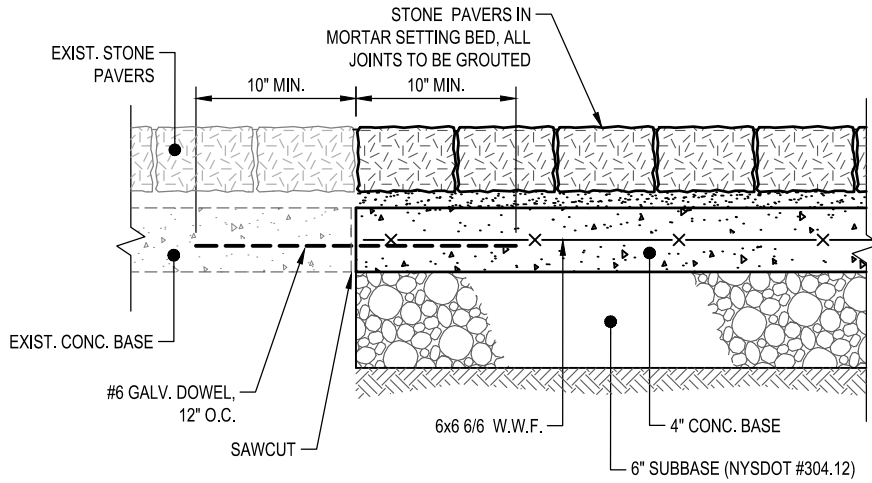

SECTION

STONE DRIVEWAY PAVERS RESTORATION

N.T.S.

NOTES:

- CONTRACTOR SHALL MATCH THE CONDITIONS OF EXISTING FLAGSTONE AND BEDDING SECTION IF DIFFERENT FROM THAT SHOW HEREON.
- FLAGSTONE PATTERN SHALL MATCH THE EXISTING PATTERN.

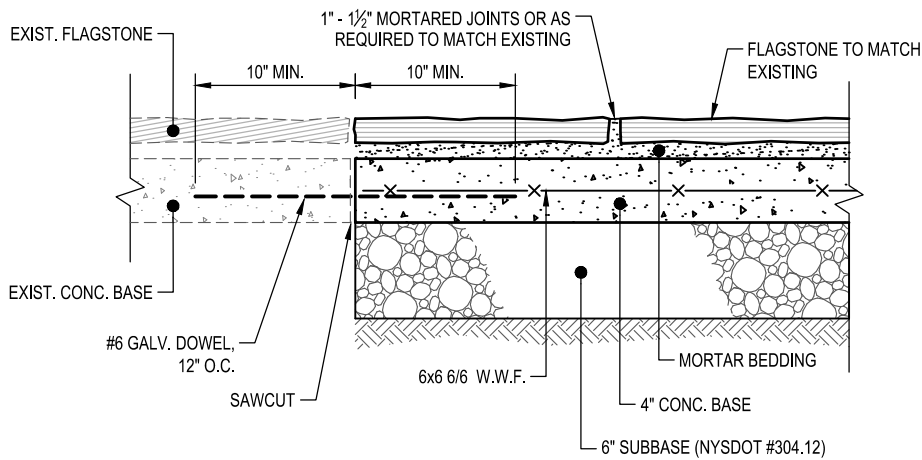

SECTION

FLAGSTONE WALKWAY RESTORATION

N.T.S.

H:\Hastings-on-Hudson\109029-Roadway Improvements 2023\details\details-109023.dwg | 4/12/2023 8:48:09 AM

| | | | | | |
|------|------|-------------|---------|---|--|
| | | | TITLE | DETAILS (SHEET 4) | |
| | | | PROJECT | 2023 CURB INSTALLATION & REPLACEMENT CONTRACT | |
| REV. | DATE | DESCRIPTION | | | |

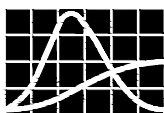

JAMES J. HAHN
ENGINEERING, P.C.

Putnam Business Park
1689 Route 22
Brewster, New York 10509
Tel: (845) 279-2220

| | | | |
|-------------|----------|-----------|---------|
| SCALE | AS NOTED | DATE | 3/31/22 |
| DRAWING NO. | D-4 | SHEET NO. | 4 OF 4 |